

This sheet is to be read in conjunction with the following drawings: GLY0268 LP 01-02

Landscape Specification

This sheet sets out the standard landscape specification that the proposed landscaping contract shall be implemented in accordance with. It is the responsibility of the appointed Contractor to read and fully comply with the Landscape Specification set out hereafter. Not all landscape features listed below may be present on the proposed designs, but are included for completeness and to ensure landscape features introduced in later design revisions are accounted for.

Please note this landscaping scheme will be audited following installation. Audits will thoroughly inspect overall workmanship, the species, pot size, height and location of all specified soft landscaping, hard landscaping and external furniture; and the consistency between the contract drawings and site installation. Any omissions, substitutions or inconsistencies with the contract specification (including, but not limited to, trees, specimens, shrubs, hedgerows, hard landscaping elements etc.) without written agreement of the Client will be identified to the Contractor and remediated at their expense.

For instances where the site layout differs from that shown on this plan, before proceeding with installation, please contact the Landscape Architect initialled in the title block using the phone number or email address provided at the bottom-left corner of this plan.

Soft Landscaping

General Specification: All plants shall conform to BS 3956 and be in accordance with the National Plant Specification. Supplying nurseries shall be registered under the HTA Plant Health Certification Scheme. All plants shall be packed and transported in accordance with good horticultural practice. No species, variety, size or position to be amended without the Landscape Architects prior approval.

All landscape proposals must be referred to by the Structural Engineer during foundation design. All tree and shrub locations and species must be taken into consideration to ensure that foundation design accords with the specifications set out under Chapter 4.2 of the NHC Standards. No species, size or location of planting stock to be changed without prior approval of the Landscape Architect and Client.

All planting to be completed in accordance with good horticultural practice.

Planting Conditions and Location: All planting has been specified making every effort to avoid conflict with highway land. Prior to submission it is the clients responsibility to ensure that all landscaping is reviewed by the project manager/highway engineer to ensure there is no conflict with highway land and future adoptions.

If planting conditions are particularly poor (e.g. waterlogged/frozen ground or poor soils), the Site Manager must be notified. All works will halt until conditions are considered acceptable. No planting should take place above concrete haunching. Plants should be suitably offset from adjacent surfacing in line with the specifications outlined below or as otherwise agreed with the Landscape Architect and Client.

Any planting stock specified in pedestrian visibility splays and exceeding 600mm in height is to be cut down to 450mm in height at the time of planting. It shall be maintained at a height not exceeding 600mm in height in perpetuity. If being transferred to private ownership, residents will be advised of this requirement.

Lawn Edges & Mulching: All planting beds are to be neatly defined with a clean edge cut into turf areas using an edging iron. In seeded areas, a suitable edge is also to be formed with an edging iron, and the bed left free of surplus seed. All planting beds and hedgerows are to be mulched with a 75mm layer of bark mulch following planting, with exception to native planting areas that are to be mulched only in the locations identified in the specification below.

Watering & Maintenance: Following planting, all trees and shrubs are to be watered to field capacity. An ongoing watering programme should be prepared to ensure plant establishment. No strimming operations are permitted within 500mm of all planting stock. No mowing operations within 500mm of all trees.

Ground Preparation: If the formation level is compacted it should be ripped at 15m centres using a single line ripper prior to topsoiling and soft landscaping works. Topsoil depths to be 300mm for shrub beds and 150mm for grass areas, excluding meadow grassland. For meadow grassland, all areas shall be stripped of topsoil to provide a nutrient-poor substrate for meadow establishment. Topsoil shall be supplied in accordance with BS3882:2015. All soils shall be adequately stonепecked, free of debris or litter and cultivated to a suitable tilth for planting or seeding works in line with good horticultural practice. A suitable peat-free compost or soil conditioner is to be used where nutrient-poor soils are identified.

Trees: All tree locations and species must be taken into consideration by the project Structural Engineer to ensure that foundation design accords with the specifications set out under Chapter 4.2 of the NHC Standards. It is the Contractors responsibility to ensure that all underground services have been located and identified in advance of tree pit excavation. Root barriers are to be provided as directed by the project Engineer and where trees are located closer to site features than the offsets recommended in Table A.1 of BS5837:2012, further guidance can be provided on request. **All trees to be supplied with a minimum 1.75m to 2.0m clear stem unless clearly specified otherwise.** Supply and aftercare shall be in accordance with BS 8545: 2014. Trees: from nursery to independence in the landscape, with aftercare proposals detailed in an accompanying management plan. All trees to be planted in accordance with the approved tree pit detail, **see Details 6 to 10.** (Root stock key: BR - Bare Root, RB - Rooted Balled, CG - Container Grown, C - Containerised). All trees planted within grass areas to be fitted with Premium Strimmer Tree Guard (Product Code: 160P51102) as supplied by Green-Tech or similar approved product.

Specimen Shrubs: Specimen shrubs to be positioned as a feature within planting beds, as indicated by the proposed design. Shrubs in the surrounding bed area to be spaced evenly in line with the proposed design.

Shrubs & herbaceous: Individual species to be planted in groups of 3-7no. within mixed species beds (proportionate groupings of lower quantities may be used where the total number of plants specified is less than 3no. per species). Low growing shrubs shall be planted to the front of the bed. All plants shall be set a minimum of 300mm back from adjacent hard surfacing and not planted above concrete haunching. **see Detail 1.**

Grasses: Individual species to be planted in groups of 3-7no. within mixed species beds (proportionate groupings of lower quantities may be used where the total number of plants specified is less than 3no. per species). All grasses are **not** to be cut back.

Single Species Hedgerows (Container): Shrubs shall be planted in a single row in a 600-800mm wide bed proportionate to the container size, with plants set back a minimum of 300mm from adjacent hard surfacing and not planted directly over concrete haunching. **see Detail 2.**

Single Species Hedgerows (Feathered): Feathered hedgerow shrubs to be planted on a single row in a 600-800mm wide bed. The feathered shrubs are to have a upright central stem furnished with evenly spread and balanced lateral growth the full length of the stem. Feathered stock to be attached to a double line support (one of 600mm high and one of 1200mm high) fence using an approved clip tie and cut back to 1200mm in height and a tidy hedgerow form at time of planting. **see Details 2 & 5.**

Instant hedging: Supplied as instant hedging in 1m troughs and planted in a trench of appropriate width (600-1000mm) and adequate depth to accommodate the hedge rootball. Sides and base of trench to be broken to aid root establishment. At the time of planting the hedge is to be lightly trimmed to its sides and top to integrate trough lengths together and provide a continuous appearance to the hedgerow canopy.

Native Transplant and Feathered Stock (Scrub, Woodland and Hedgerow Planting): All stock to be planted into an appropriate sized pit or notch. Transplanted stock is to be protected using a 750mm x 73-105mm Tubex Standard Tree Shelter (or similar approved) and secured with a 15mm diameter min. bamboo cane inserted inside the guard and with a third of its length pushed firmly into the ground. Containerised stock (e.g. leaf sp.) to be protected using a 600mm high Tubex Recycled Plastic Treeguard Mesh (or similar approved) in colour green, secured by a timber stake driven a minimum of 300mm into the ground and fixed with an appropriate tie, fitted in accordance with the manufacturer's guidelines. Mesh to be installed up to a 300mm diameter so as not to restrict stock foliage at time of planting. Feathered stock to be protected using a 600mm high Tubex Recycled Plastic Treeguard Mesh (or similar approved) in colour green, secured by a timber stake driven a minimum of 300mm into the ground and fixed with an appropriate tie, fitted in accordance with the manufacturer's guidelines. Where feathered or light standard stock exceeds 1500mm height at time of planting, 1200mm high mesh to be used. Mesh to be installed up to a 300mm diameter so as not to restrict stock foliage at time of planting. Shelters to feathered stock shall be omitted on-plot, at site frontages and at the immediate edges of the development (e.g. adjoining drives) except where there is an identifiable risk of mammal damage. All bare root stock shall be root dipped in an approved water-retaining polymer. If planting is required outside the October-March season, bare root trees will be replaced by a containerised equivalent to be approved by the Landscape Architect. Planting beds and hedgerows to site frontages or immediately adjoining the development edge (e.g. along driveways) are to be mulched with 75mm layer of bark.

Native Hedgerows (Double Staggered): Hedgerow planting stock to be planted in a double staggered row at 300mm apart with no less than 6 per linear metre. **see Detail 3.** Individual species to be planted in groups of 5-10no. within the bed, with species distributed proportionately with regular variation throughout the full length of the hedgerow. Species-rich mixes to be planted with at least 7no. species per 30m length.

Native Hedgerows (Triple Staggered): Hedgerow planting stock to be planted in a triple staggered row, 250mm apart with no less than 12no. per linear meter and within a 950mm wide bed. **see Detail 9.** Individual species to be planted in groups of 5-10no. within the bed, with species distributed proportionately with regular variation throughout the full length of the hedgerow. Species-rich mixes to be planted with at least 7no. species per 30m length. Feathered stock are to have an upright central stem furnished with evenly spread and balanced lateral growth the full length of the stem. Feathered stock to be attached to a double line support (one for the feathered howlorn of 1200mm high and one for Ironplants of 600mm high) fence using an approved clip tie and cut back to 1000mm in height and a tidy hedgerow form at time of planting. **see Detail 5.**

Native Scrub & Woodland Planting: Individual species to be planted in groups of up to 15no. within the bed, with species distributed proportionately with regular variation throughout the full bed.

Marginal & Aquatic species: Individual species to be planted in groups of up to 20no. within the bed, with species distributed proportionately with regular variation throughout the full bed. Plugs to be planted in a suitable notch and firmed into the ground.

Amenity Turf & Seeding: Seed to be applied at the rates (g/m2) advised by manufacturer/supplier. Prior to seeding, ground shall be cultivated to a fine tilth incorporating 150mm of topsoil to finished formation level. All areas shall be free of weed growth and stonепecked prior to turfing/seeding.

Meadow & Wildflower Grassland: Seed to be applied at the rates (g/m2) advised by manufacturer/supplier. Prior to seeding, **all areas shall be stripped of topsoil to provide a nutrient-poor substrate for meadow establishment.** Where ground requires additional soil fill to meet finished formation levels this shall be made up using site-won subsoil.

Bulbs: Individual species to be planted in drifts or groups of 25-50no. (proportionate groupings of lower quantities may be used where the total number of plants specified is less than 25no. per species).

Hard Landscaping

The Landscape Contractor shall ascertain the location of services or utilities from the Site Manager prior to any proprietary excavation being carried out. A CAT scanner will be used over all areas prior to excavation. Any damage to services or utilities occurring at the fault of the Contractor shall be repaired at their expense. Any services or utilities restricting the implementation of the proposed landscaping scheme shall be brought to the attention of the project Landscape Architect prior to commencement of works.

All hard landscaping products shall be installed in strict accordance with the manufacturer guidelines. Unless otherwise stated, the hard landscaping specifications provided on this drawing are for planning purposes only. Detailed construction drawings must be prepared prior to implementation. All construction details must be prepared in consultation with the project engineer and taking into the account the soil bearing ratio and vegetation influence. Longfall should not exceed 1:21 unless otherwise agreed and a crossfall of 1:40 or similar must be provided to aid positive drainage.

Any defective and damaged products shall be rejected by the Contractor. Significant variations in product quality, colour or finish shall not be accepted and if installed will be replaced at the Contractor's expense.

Cutting of materials and paving shall be completed to ensure products are free from chips, splintering and sharp or abrasive edges. Any curved elements shall have the radius marked out prior to cutting. Finished edges in natural stone products shall be dressed to ensure the sawn edge bares a similar finish to the typical product finish (eg. smooth or ivory).

The Contractor will prepare a RAMS (risk assessment and method statement) prior to completing any hard landscaping works and provide a copy to the Site Manager.

Typical Soft Landscaping Setting Out Details

Detail 1 - Typical Shrub Planting Layout (N.T.S.)

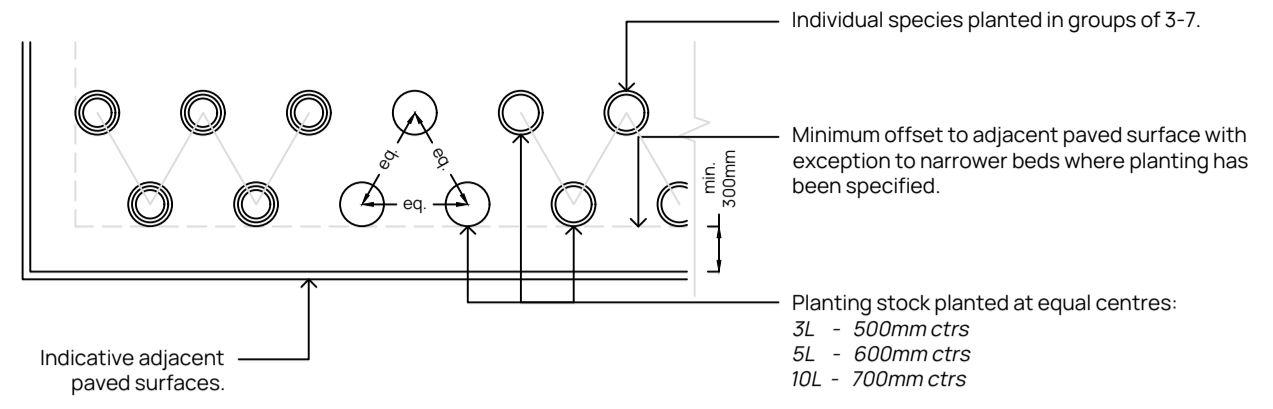

Detail 2 - Typical Single Row Hedgerow Layout (N.T.S.)

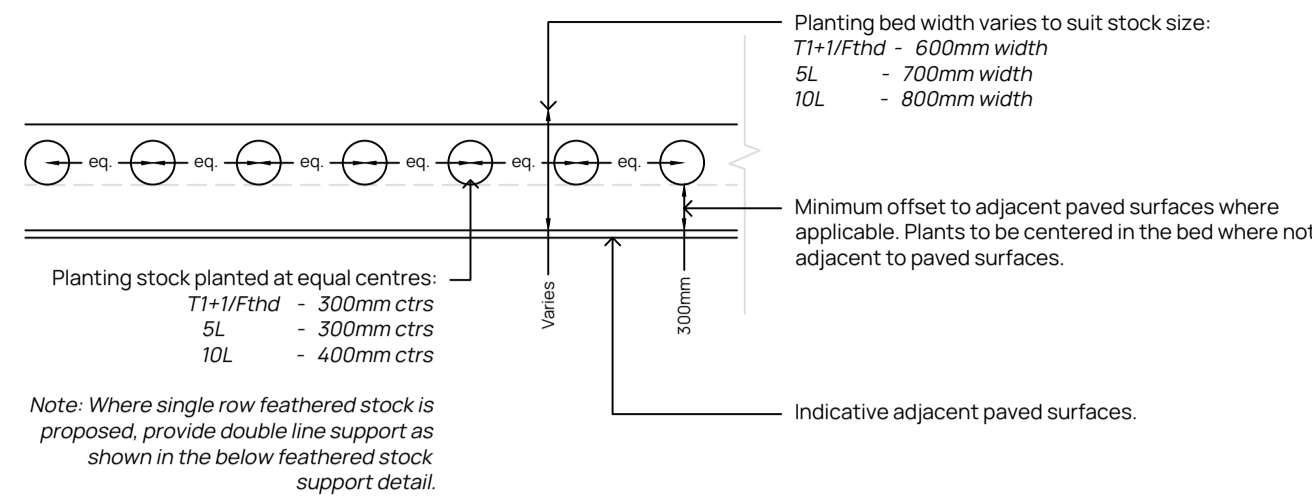

Detail 3 - Typical Native Hedgerow Double Staggered Layout (N.T.S.)

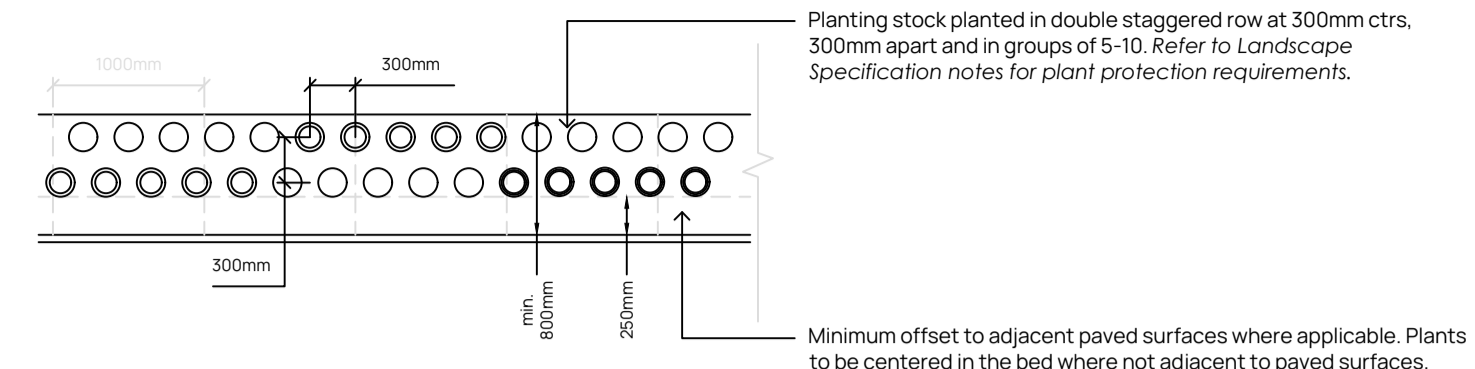

Detail 4 - Typical Native Hedgerow Triple Staggered Layout (N.T.S.)

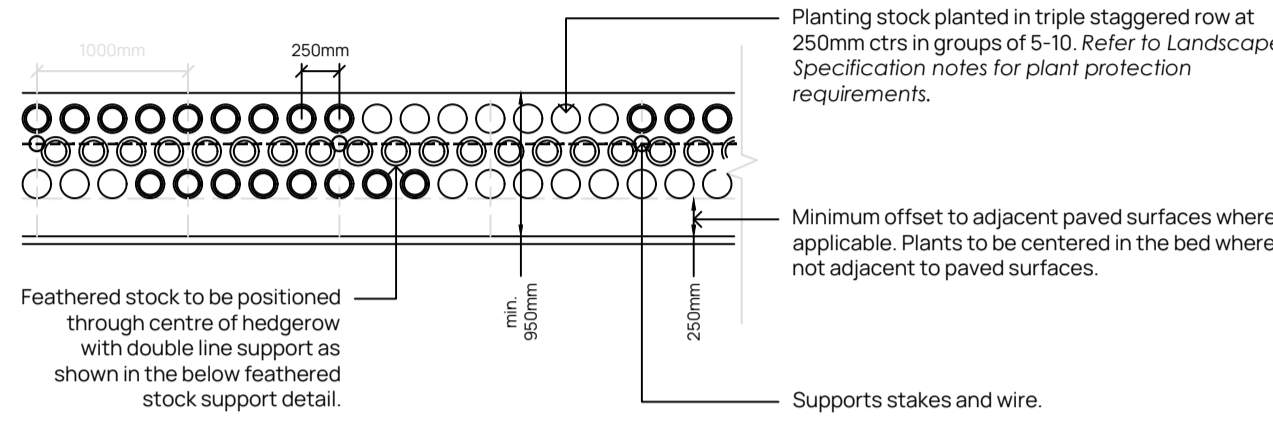

Detail 5 - Typical Feathered Stock Support Detail (N.T.S.)

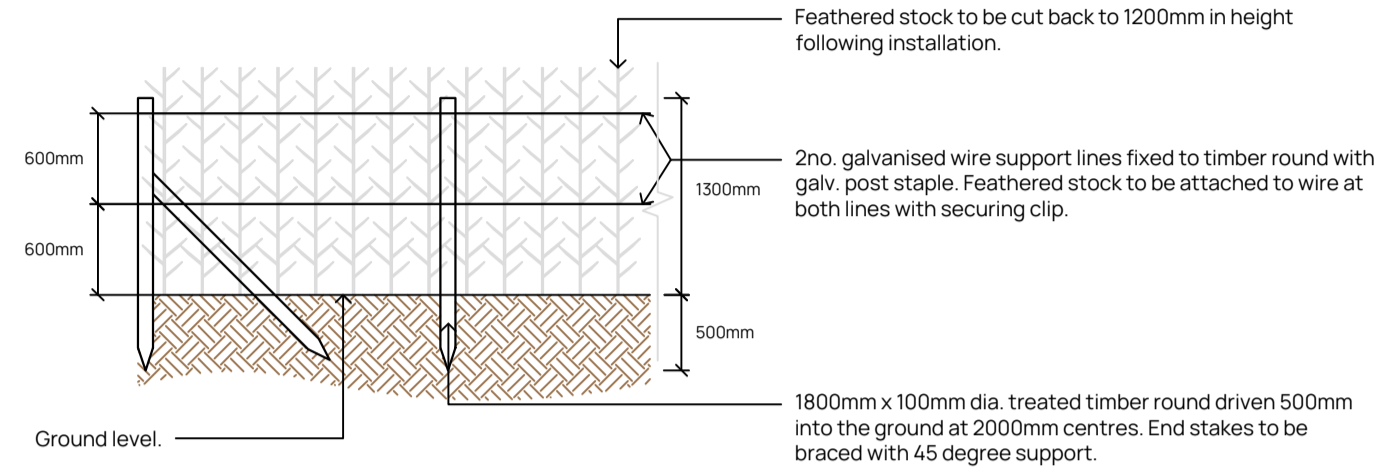

Typical Tree Pit Dimensions

Tree Pit & Support System Guide

Tree Girth	Size	Min. Rootball Diameter	Min. Tree Pit Width	Support System	Height of stake above ground
8-10cm	Standard (Std)	300mm	900mm	Single Stake	
10-12cm	Select Standard (SStd)	300mm	900mm	Single Stake	
12-14cm	Heavy Standard (HStd)	400mm	1000mm	Double Stake	
14-16cm	Extra Heavy Standard (EHStd)	450mm	1050mm	Double Stake	
16-18cm	Extra Heavy Standard (EHStd)	500mm	1100mm	Double Stake	
18-20cm	Extra Heavy Standard (EHStd)	550mm	1150mm	Double Stake	
20-25cm	Semi Mature (SM)	600mm	1200mm	Double Stake	
25-30cm	Semi Mature (SM)	700mm	1300mm	Anchor System	
30-35cm	Semi Mature (SM)	800mm	1400mm	Anchor System	
35-40cm	Semi Mature (SM)	900mm	1500mm	Anchor System	
40-45cm	Semi Mature (SM)	1000mm	1600mm	Anchor System	
45-50cm	Semi Mature (SM)	1200mm	1800mm	Anchor System	
50-60cm	Semi Mature (SM)	1300mm	1900mm	Anchor System	

- Notes:
- Anchor system to be used on all trees within hard landscape.
 - Above ground staking for 25cm+ trees may also be required in addition to the anchoring system. Supplier to confirm additional supports where required.

Detail 6 - Standard to Select Standard Support Detail

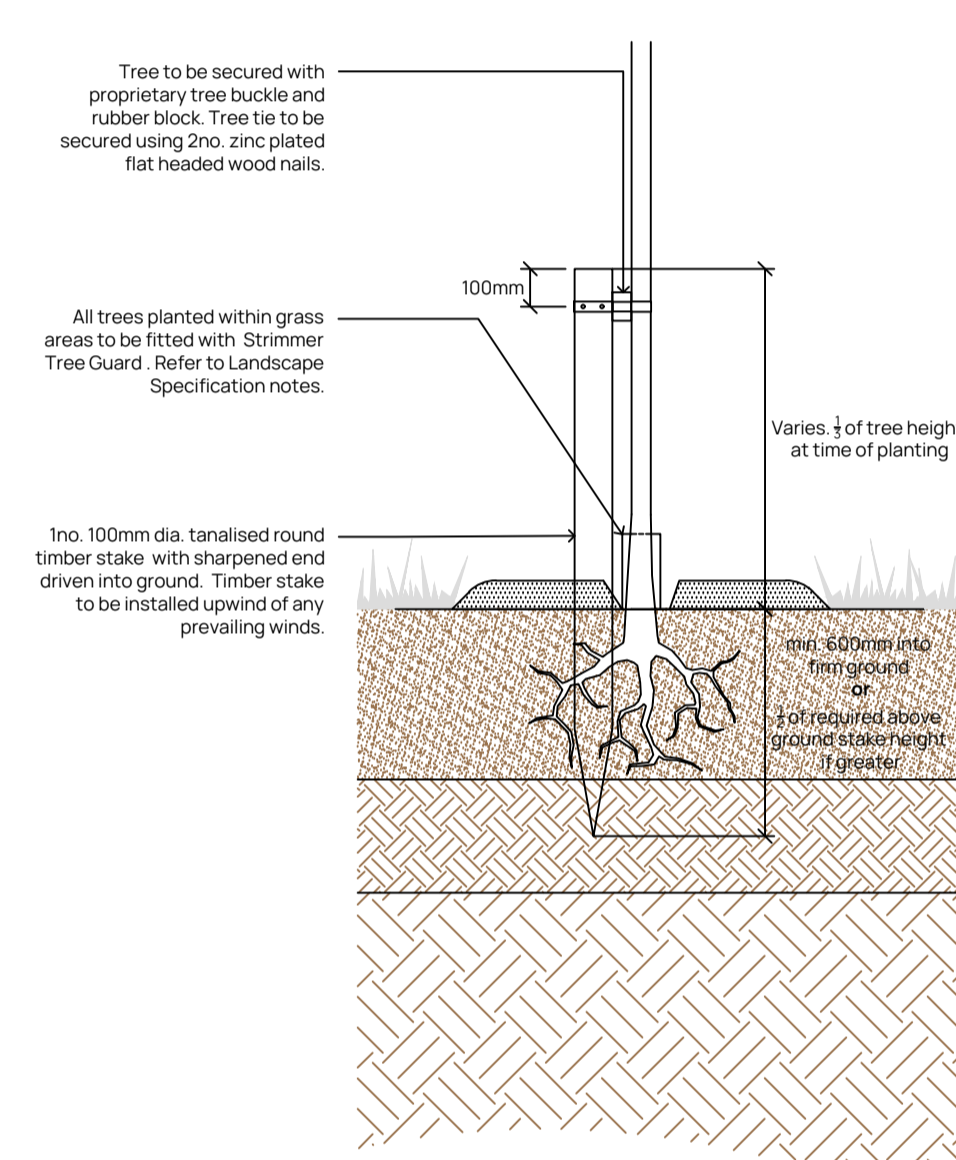

Detail 7 - Heavy Standard to Semi Mature Support Detail

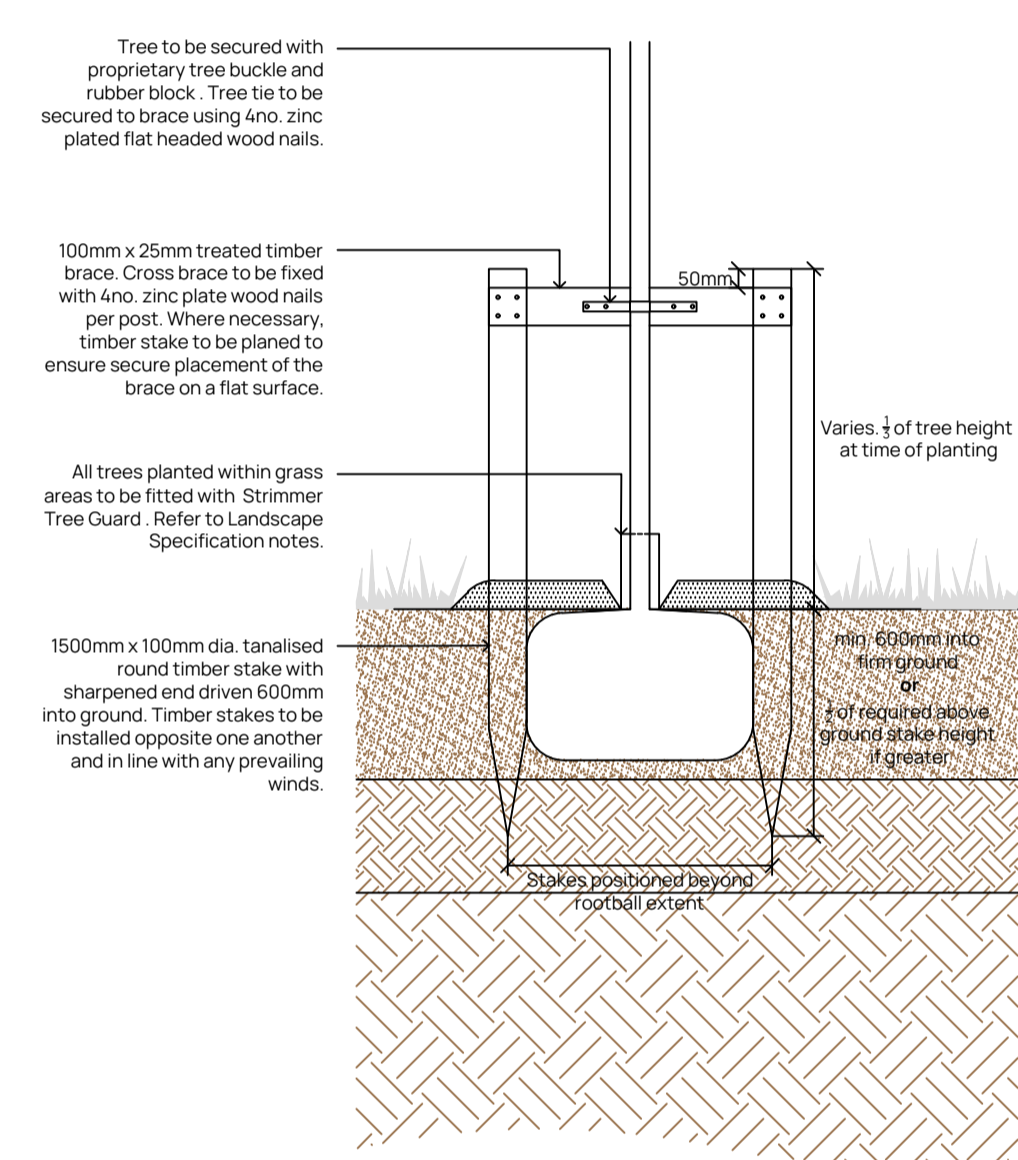

Detail 8 - Typical Semi Mature 25cm+ Girth Support Detail

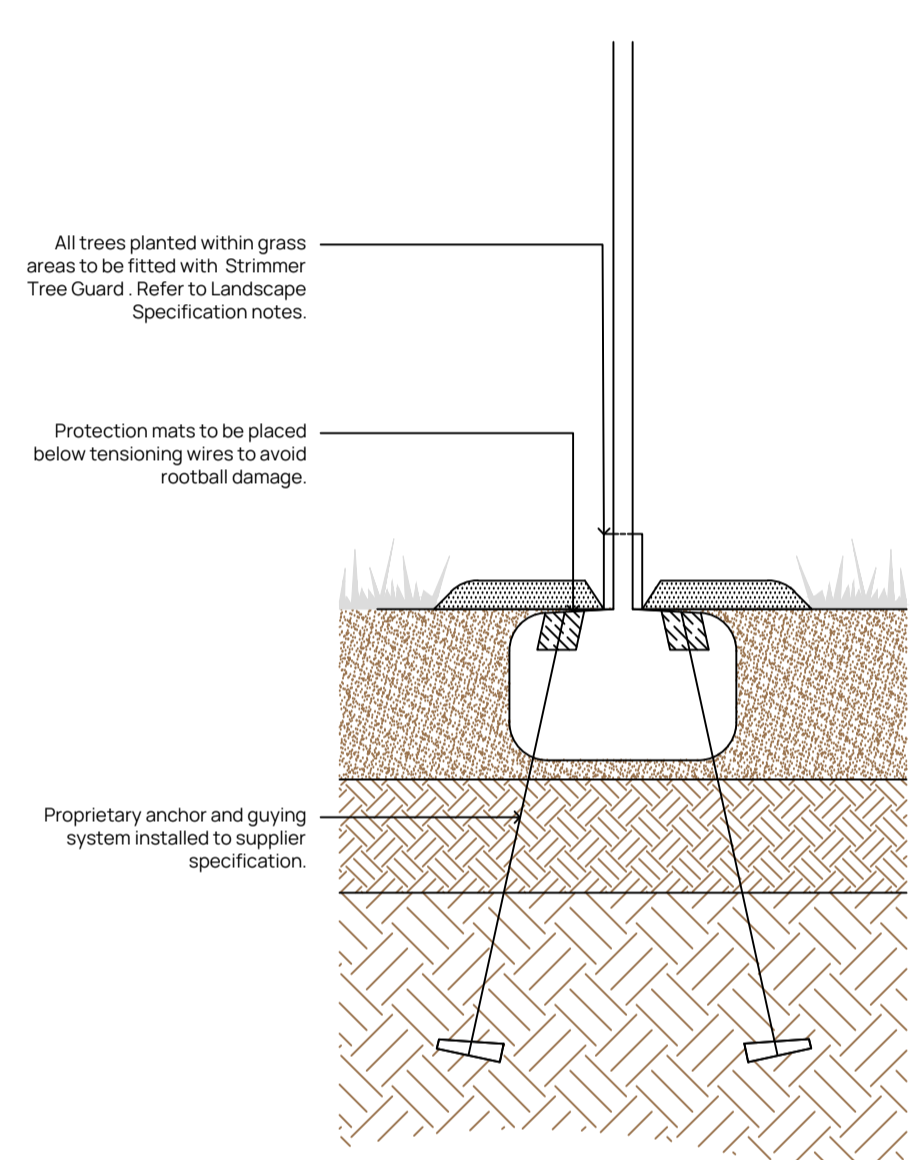

Typical Tree Pit Details

Detail 9 - Typical Tree Pit within Soft Landscape (N.T.S.)

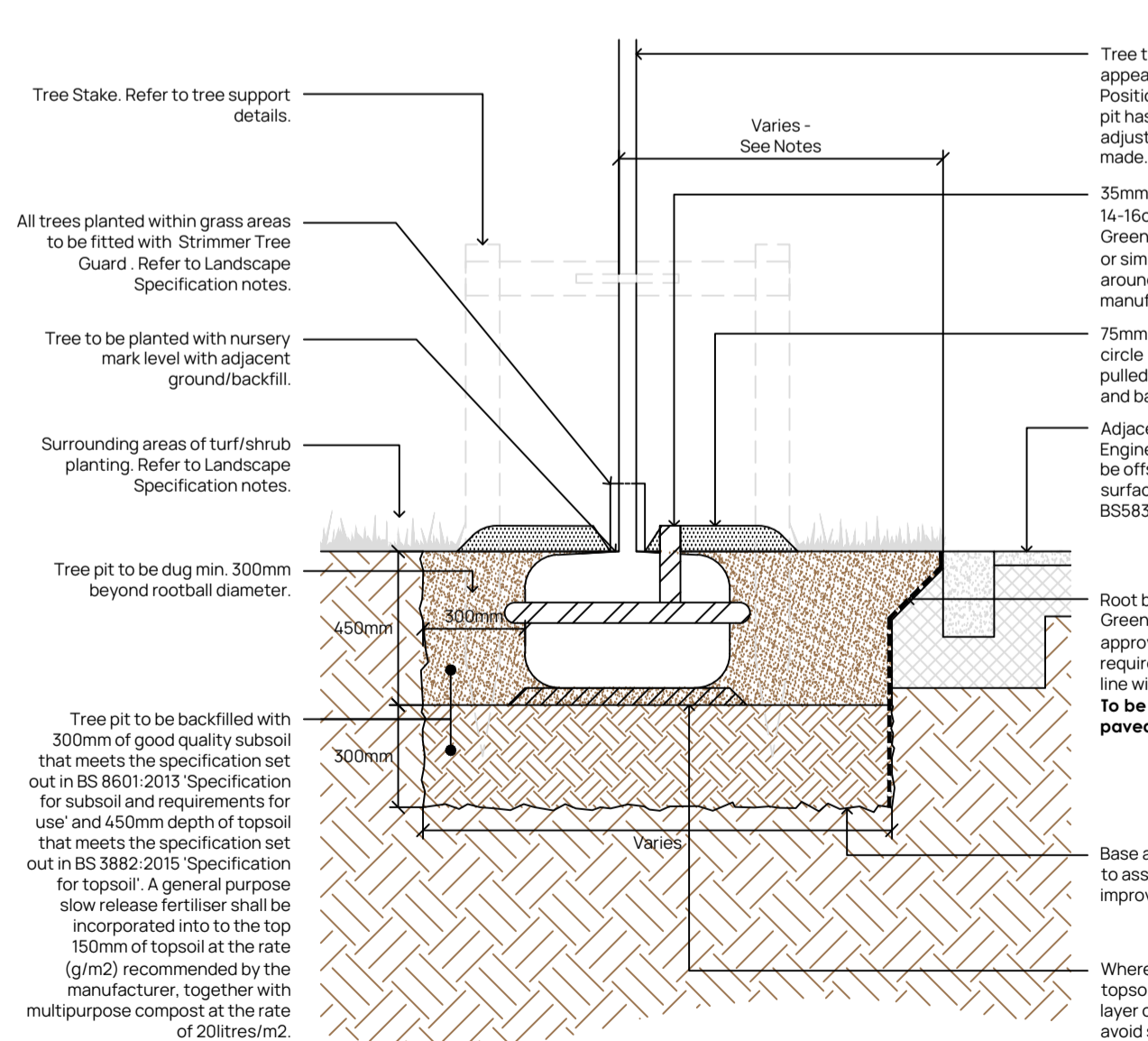

Detail 10 - Typical Tree Pit within Hard Landscape (N.T.S.)

