

PROPOSED CHANGE OF USE FROM SHOP  
 TO HOT FOOD TAKE AWAY & EXTENSION  
 TO REAR at No 35 HIGH STREET, GREAT  
 HOUGHTON for Mr. H. MAHMOODZADEGAN.  
 Scale ~ 1:100

AMENDED PLAN No 2009/1493

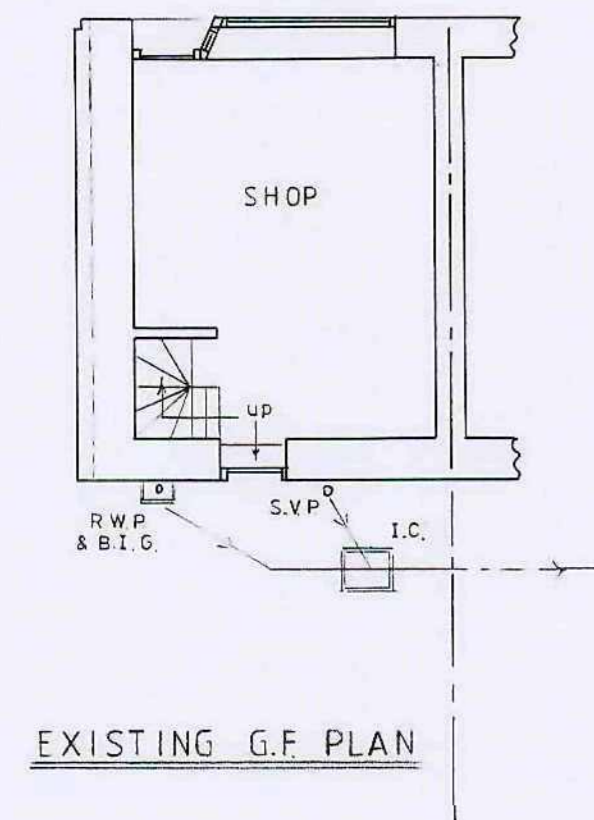

EXISTING G.F. PLAN

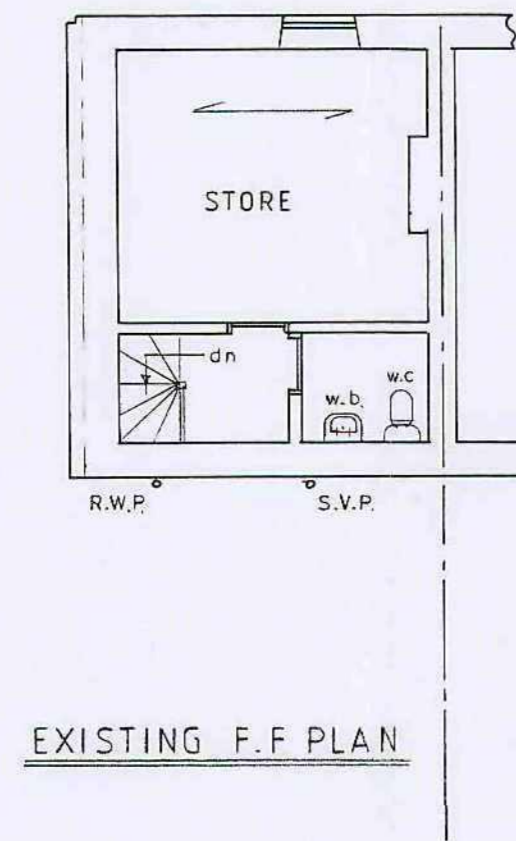

EXISTING F.F. PLAN

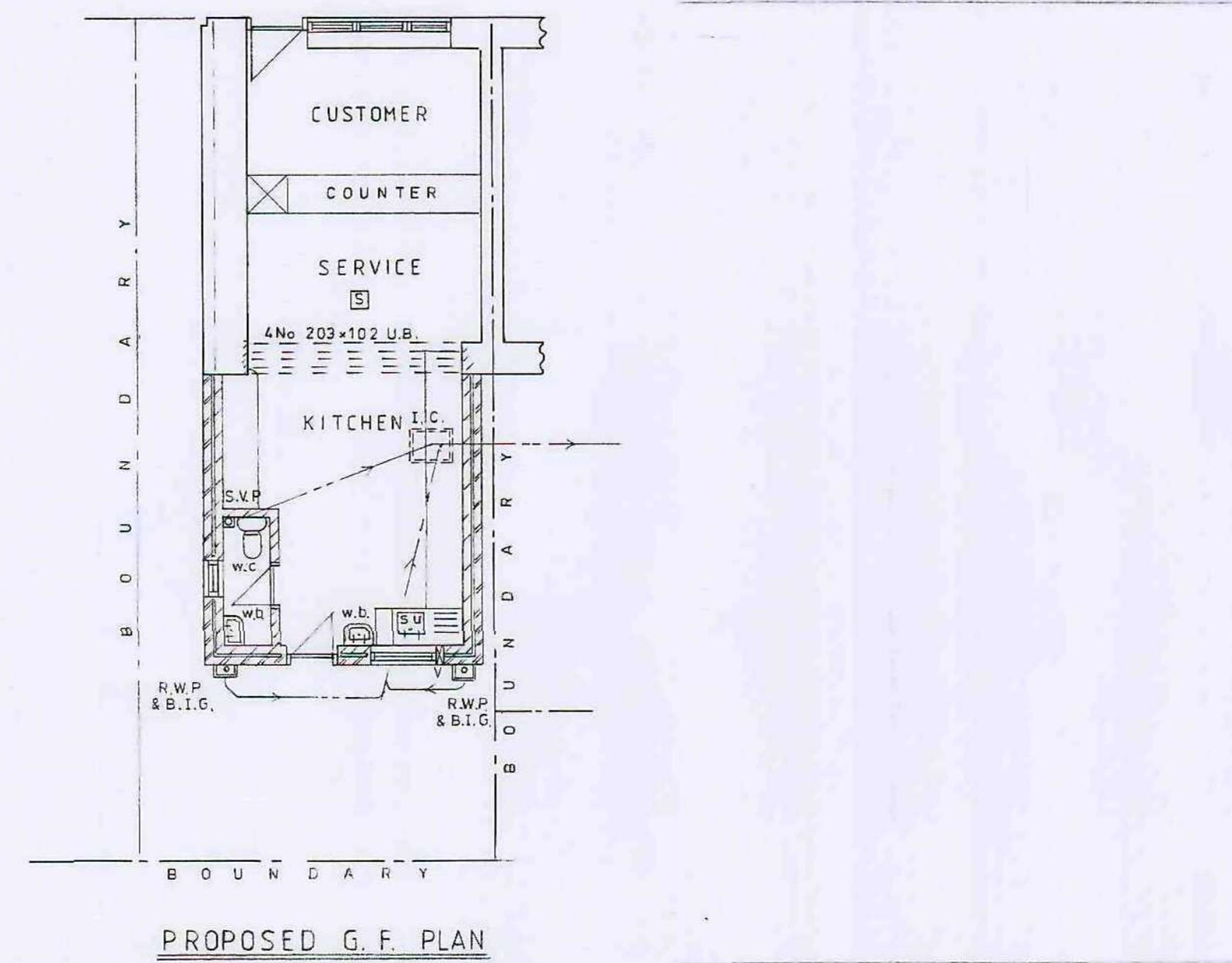

PROPOSED G.F. PLAN

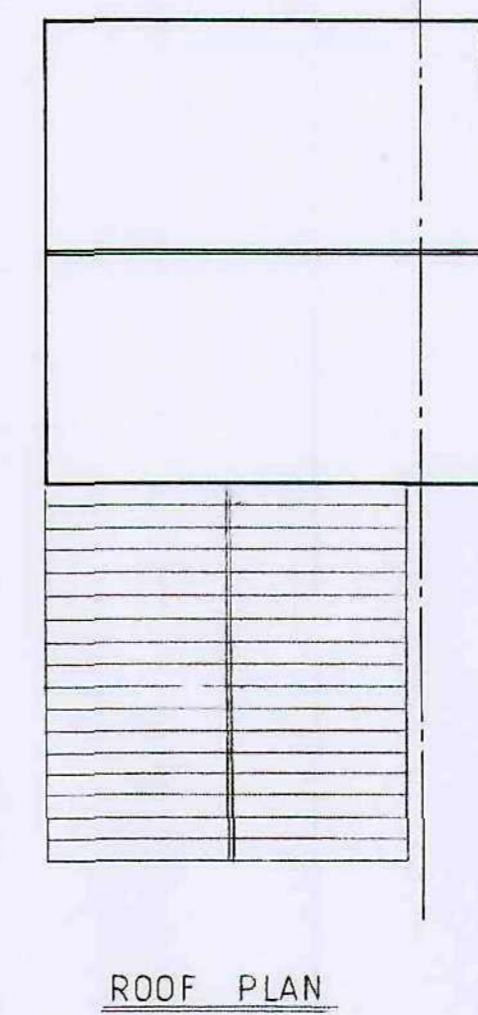

ROOF PLAN

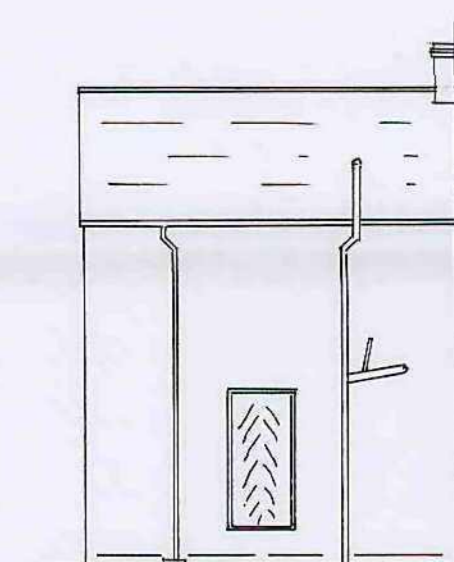
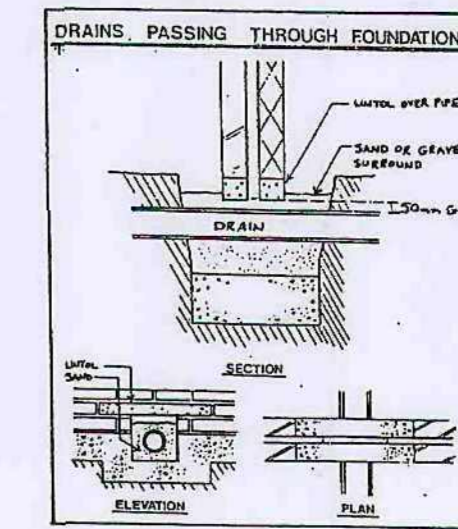

EXISTING REAR

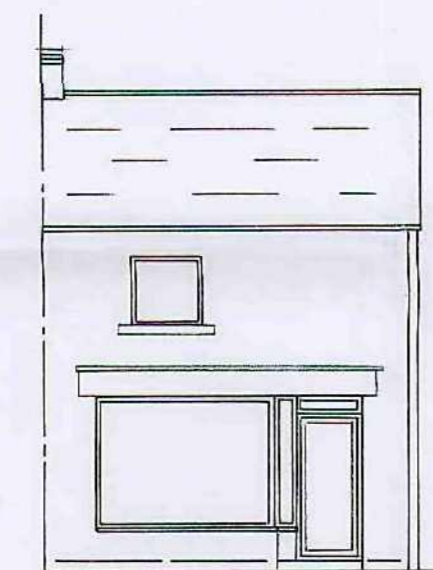

EXISTING FRONT

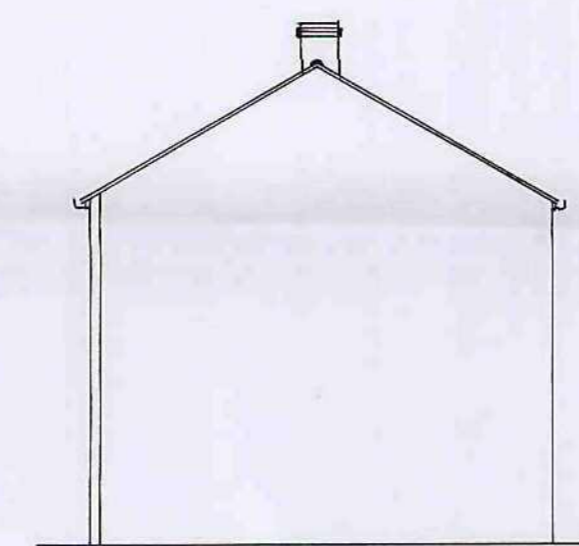

EXISTING SIDE

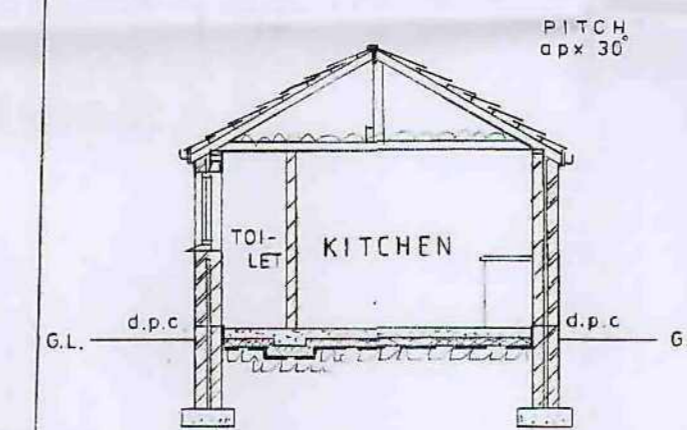

SECTION

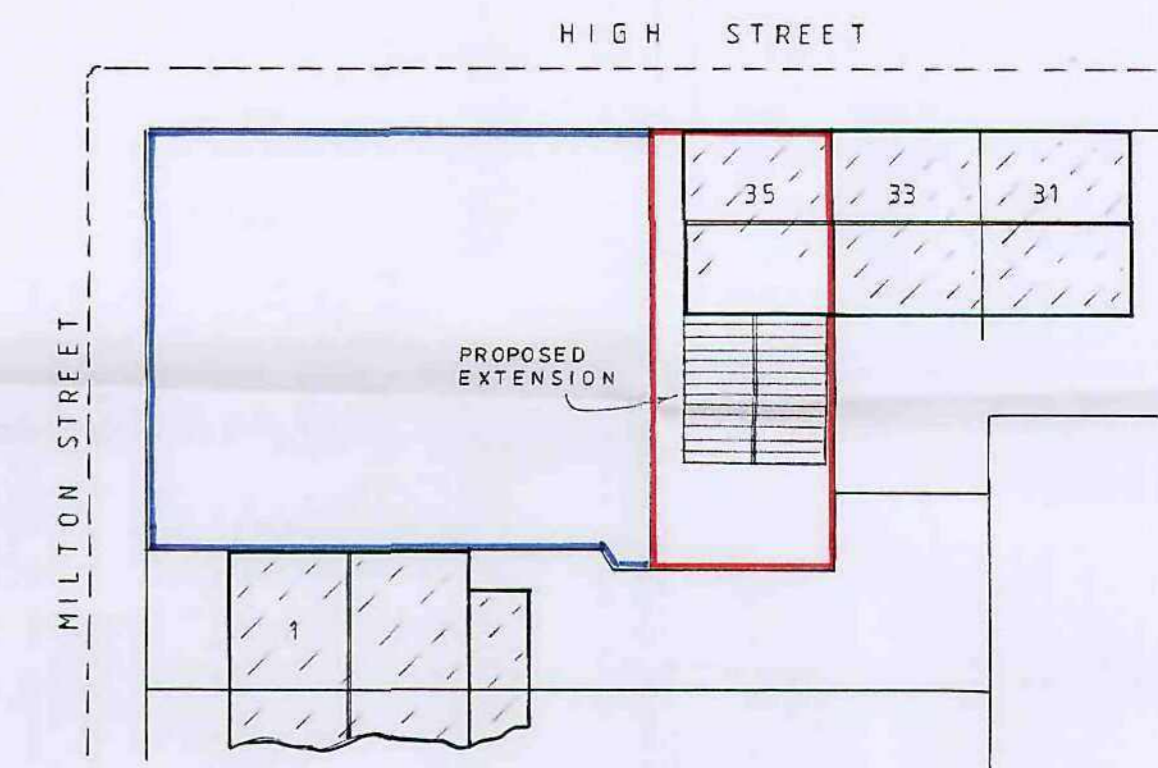

SITE PLAN 1:250

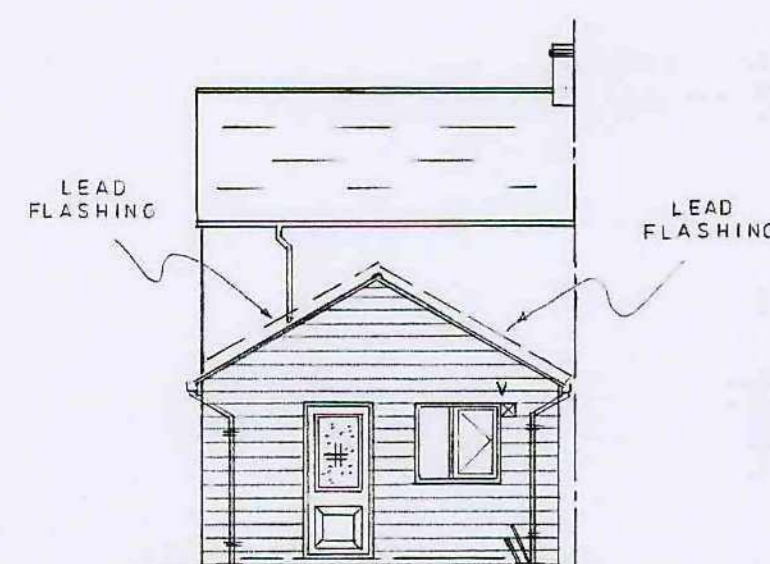

PROPOSED REAR



PROPOSED FRONT

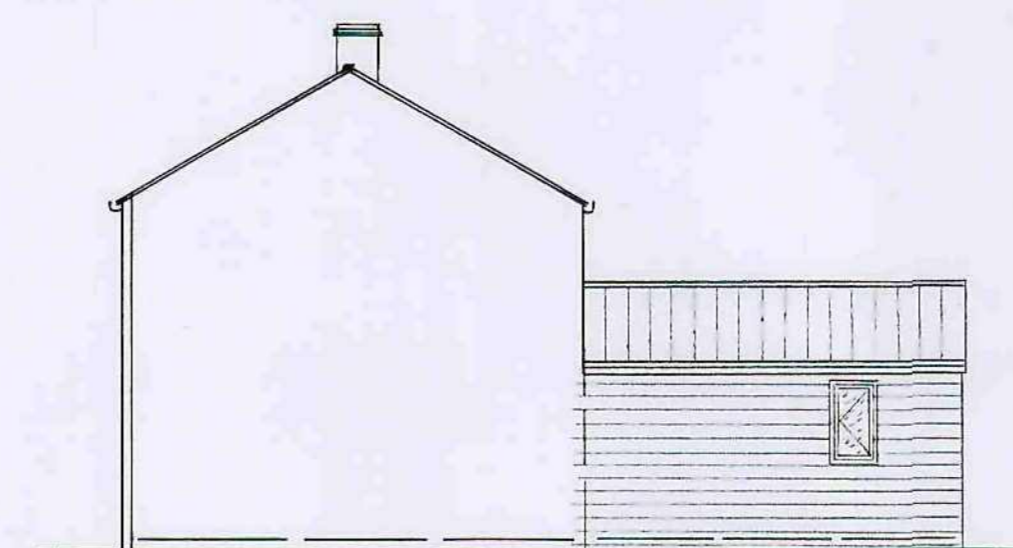

PROPOSED SIDE

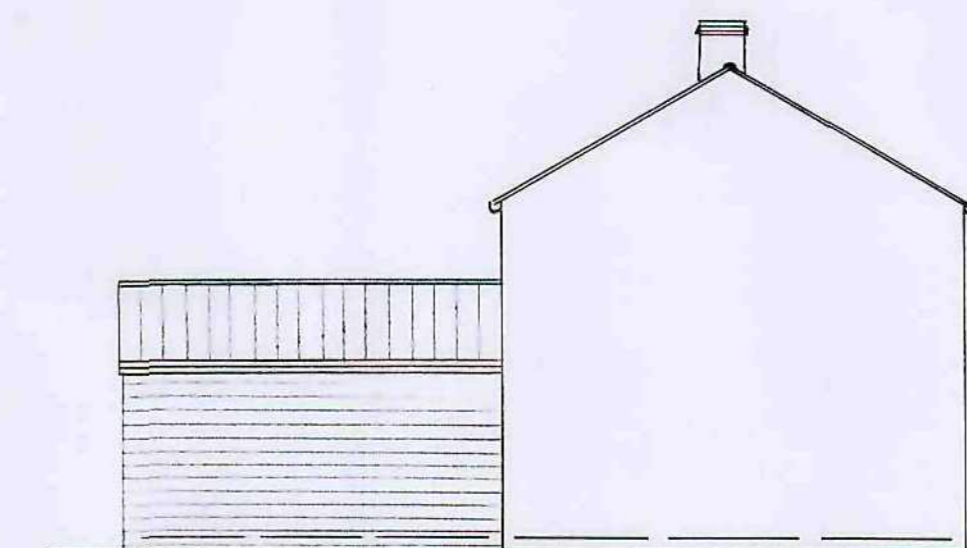

PROPOSED SIDE

