

ISSUE/REVISION

I/R	DATE	BY	DESCRIPTION
A	31/07/2019	DC	SPA BASED ON AMENDMENTS FROM ARCHITECT
-	26/07/19	DC	FIRST ISSUE

KEY PLAN

SHEET TITLE

REFUSE\_VEHICLE\_TRACKING  
SITE\_2

SHEET NUMBER

60593320-VT-LDP-002

ISSUE/REVISION

I/R	DATE	BY	DESCRIPTION
-	26/07/19	DC	FIRST ISSUE

KEY PLAN

SHEET TITLE

REFUSE\_VEHICLE\_TRACKING  
SITE\_2

SHEET NUMBER

60593320-VT-LDP-002

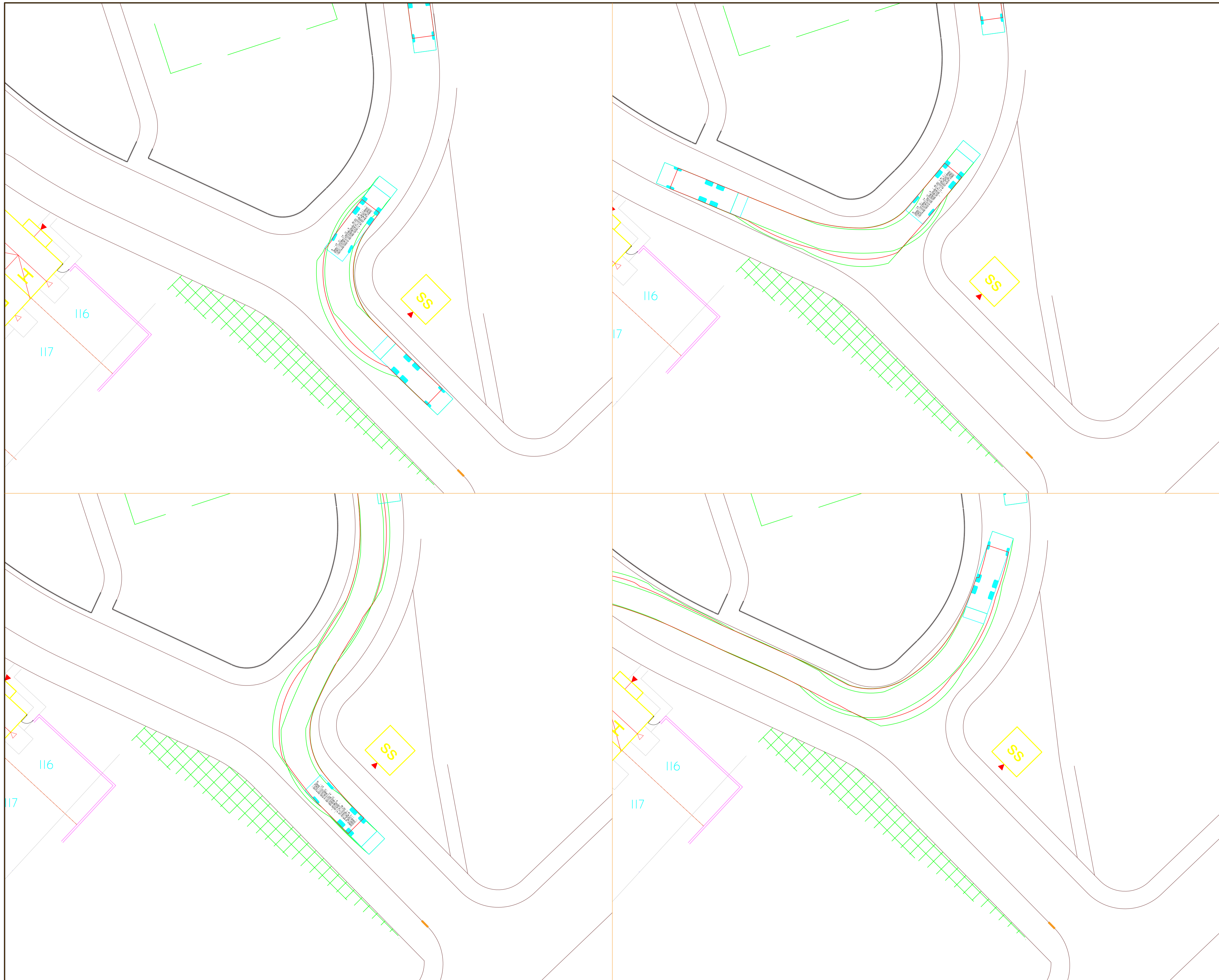

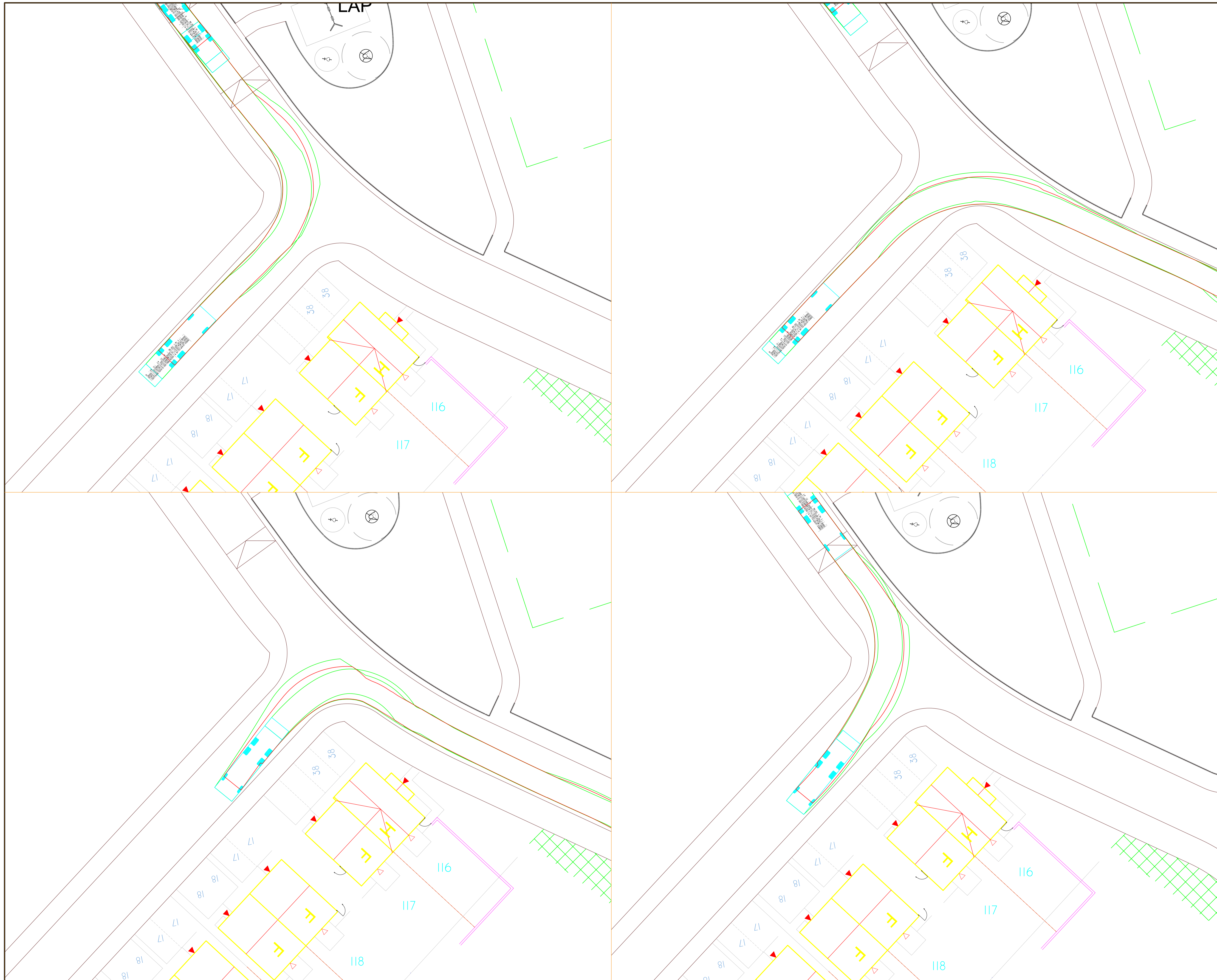

PROJECT

FORMER  
WOMBWELL  
SCHOOL

CLIENT

PREMIER  
CONSTRUCTION

CONSULTANT

AECOM LEEDS  
5th FLOOR  
2 CITY WALK  
LEEDS  
LS11 9AR  
0113 391 6800 tel  
www.aecom.com

ISSUE/REVISION

I/R	DATE	BY	DESCRIPTION
-	26/07/19	DC	FIRST ISSUE

KEY PLAN

SHEET TITLE

REFUSE\_VEHICLE\_TRACKING  
SITE\_3

SHEET NUMBER

60593320-VT-LDP-003



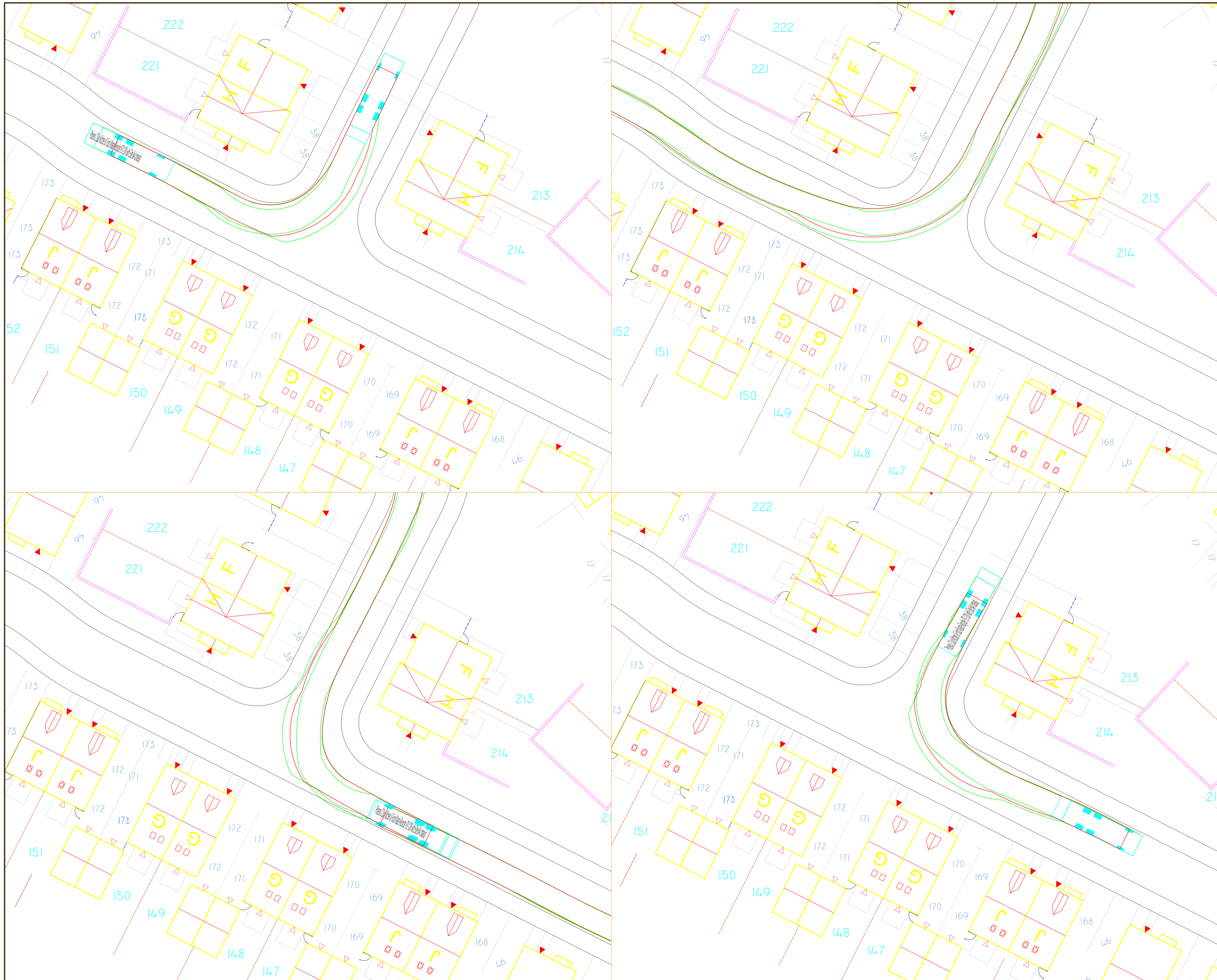

ISSUE/REVISION

I/R	DATE	BY	DESCRIPTION
-	26/07/19	DC	FIRST ISSUE

KEY PLAN

SHEET TITLE

REFUSE\_VEHICLE\_TRACKING  
SITE\_5

SHEET NUMBER

60593320-VT-LDP-005

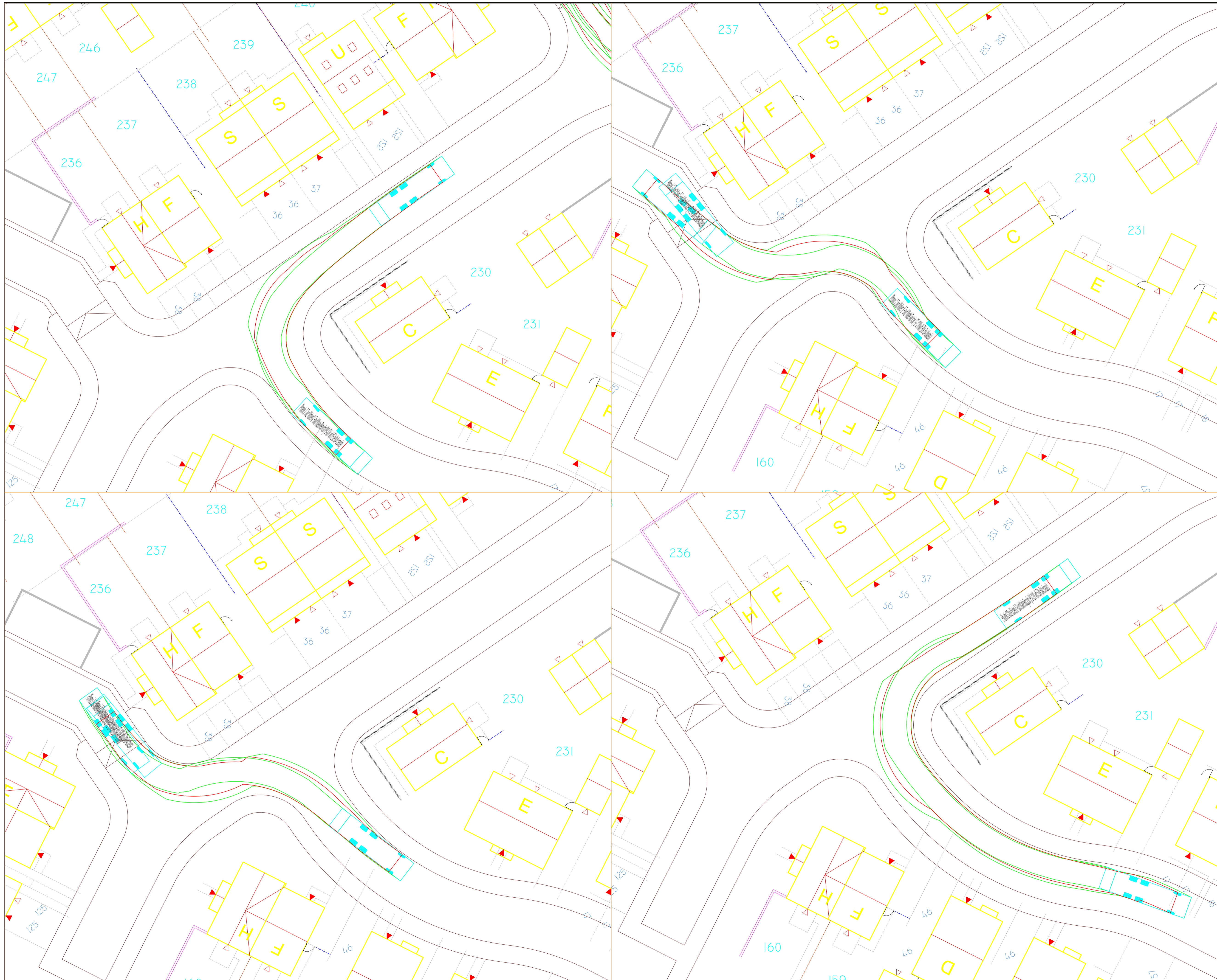

### ISSUE/REVISION

I/R	DATE	BY	DESCRIPTION
-	26/07/19	DC	FIRST ISSUE

### KEY PLAN

### SHEET TITLE

REFUSE\_VEHICLE\_TRACKING  
SITE\_6

### SHEET NUMBER

60593320-VT-LDP-006

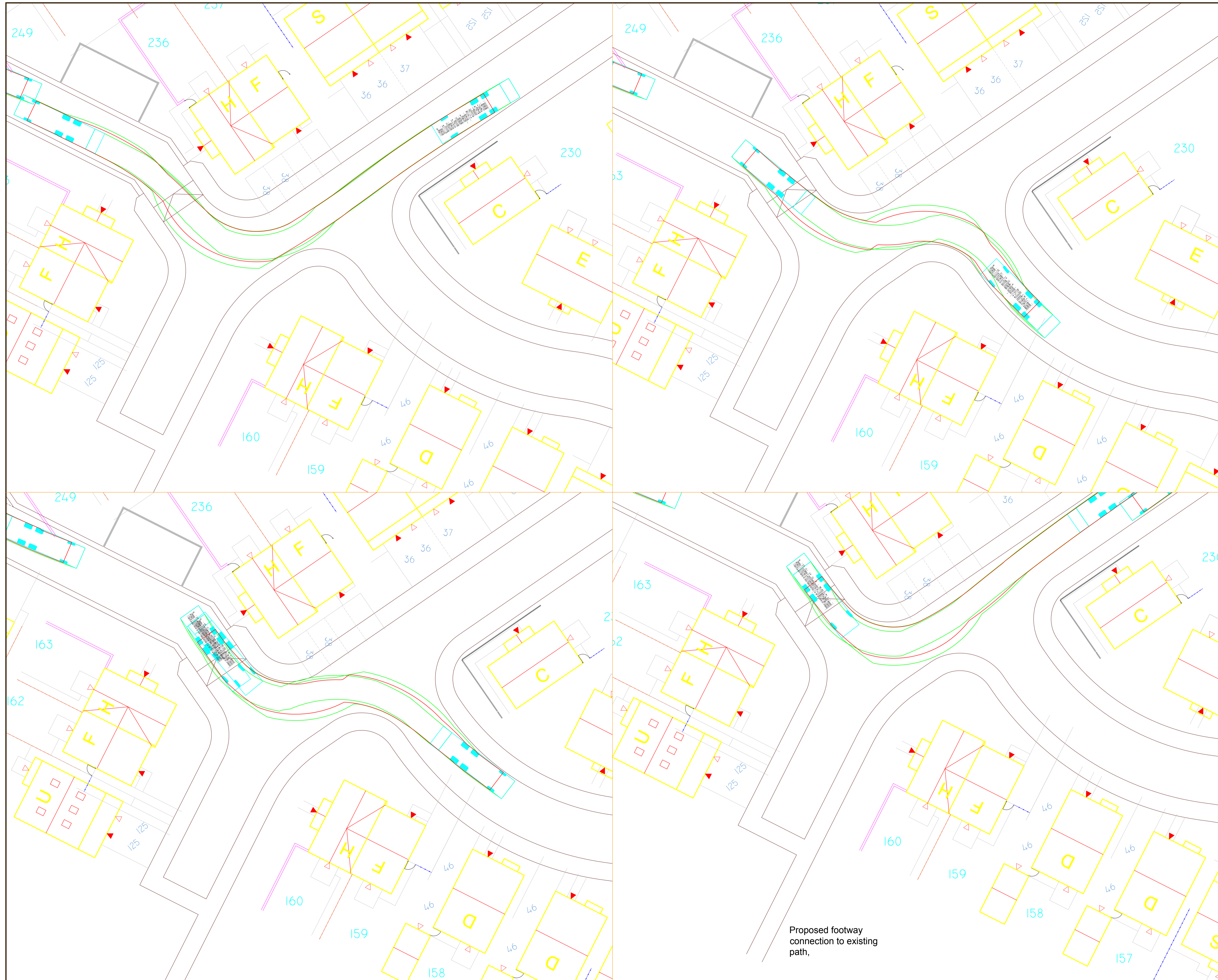

Proposed footway connection to existing path,

ISSUE/REVISION

I/R	DATE	BY	DESCRIPTION
-	26/07/19	DC	FIRST ISSUE

KEY PLAN

SHEET TITLE

REFUSE\_VEHICLE\_TRACKING  
SITE\_7

SHEET NUMBER

60593320-VT-LDP-007

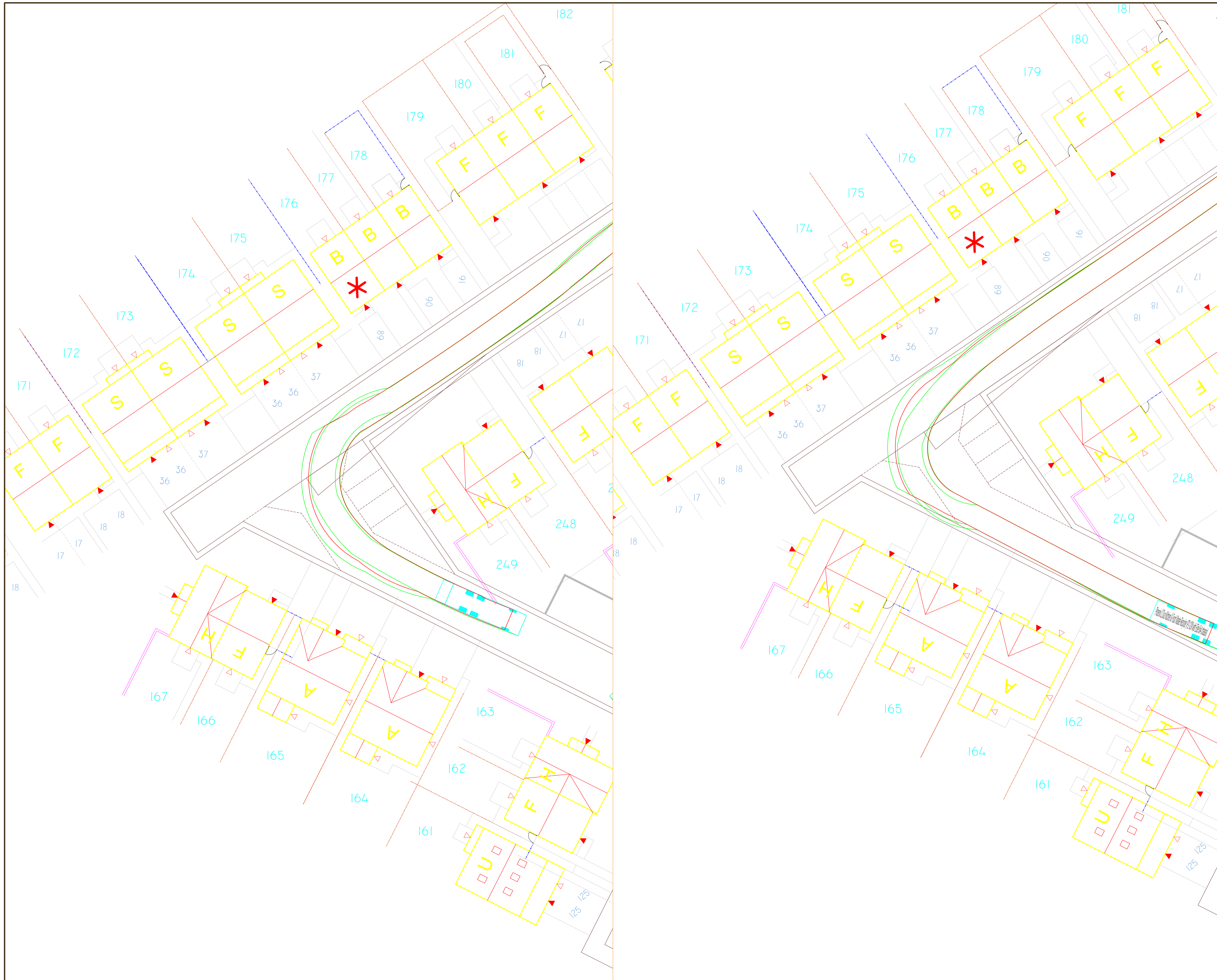

ISSUE/REVISION

I/R	DATE	BY	DESCRIPTION
-	26/07/19	DC	FIRST ISSUE

KEY PLAN

SHEET TITLE

REFUSE\_VEHICLE\_TRACKING  
SITE\_8

SHEET NUMBER

60593320-VT-LDP-008

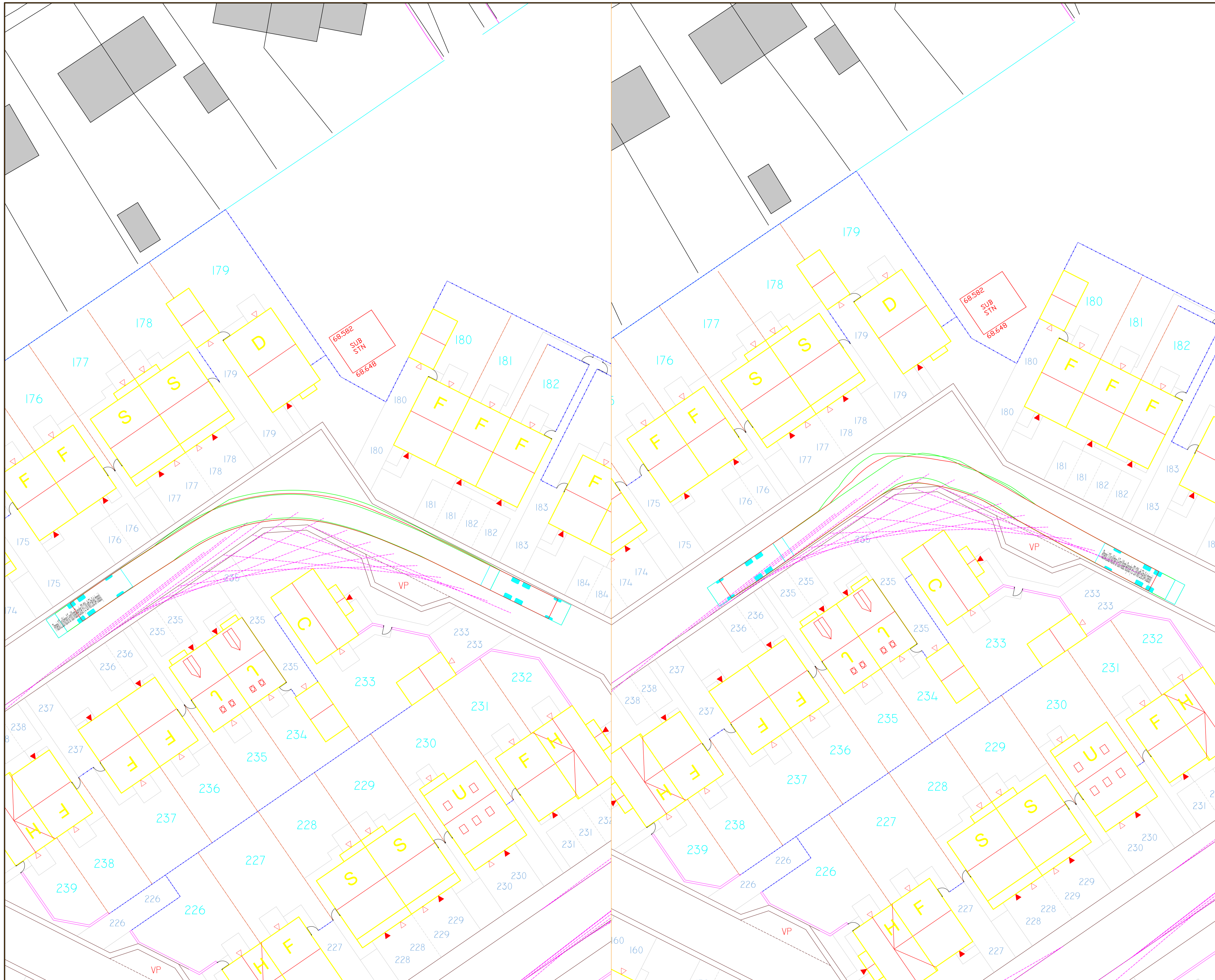

ISSUE/REVISION

I/R	DATE	BY	DESCRIPTION
A	31/07/2019	DC	SPA BASED ON AMENDMENTS FROM ARCHITECT
-	26/07/19	DC	FIRST ISSUE

KEY PLAN

SHEET TITLE

REFUSE\_VEHICLE\_TRACKING  
 SITE\_9

SHEET NUMBER

60593320-VT-LDP-009

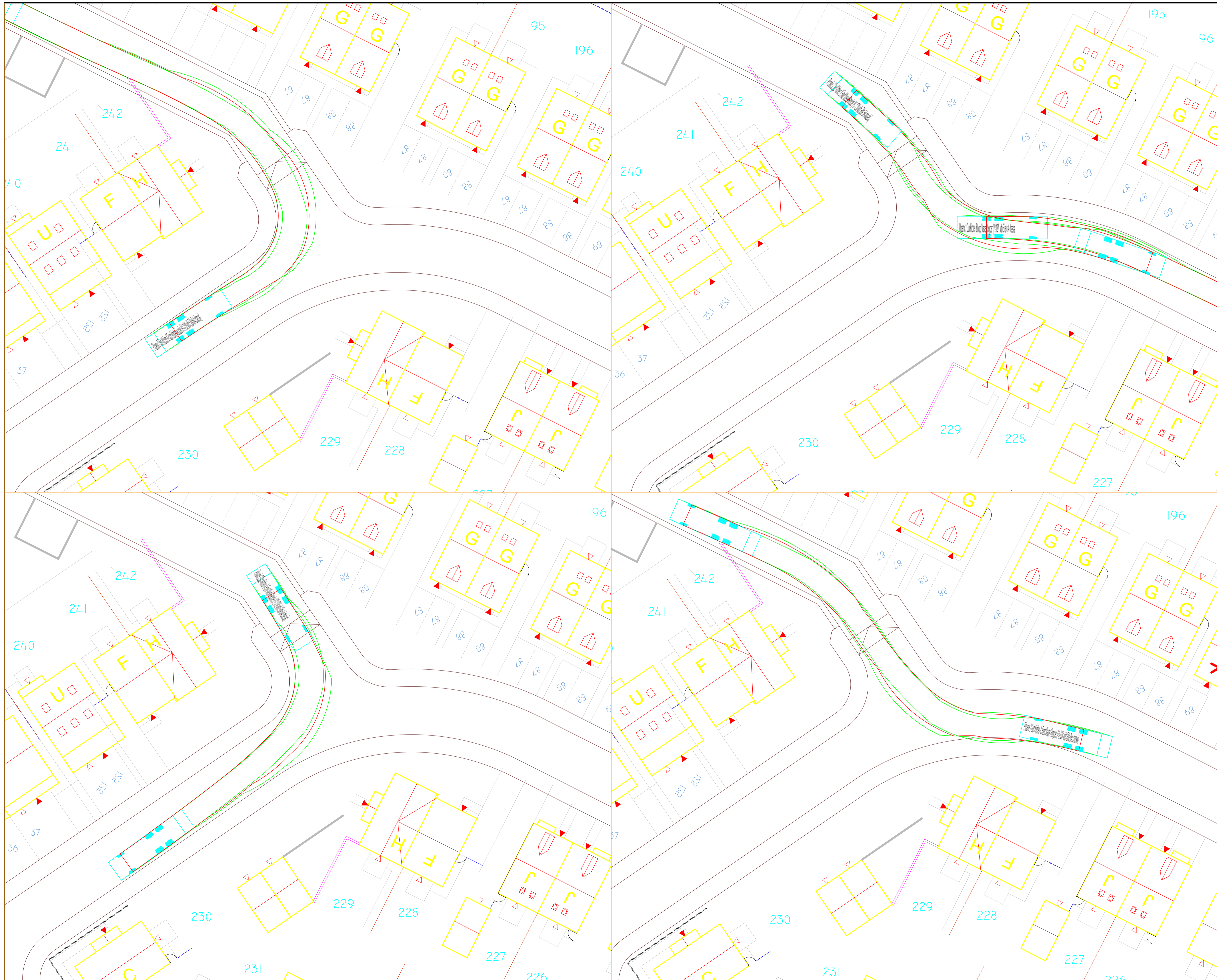

PROJECT

FORMER  
WOMBWELL  
SCHOOL

CLIENT

PREMIER  
CONSTRUCTION

CONSULTANT

AECOM LEEDS  
5th FLOOR  
2 CITY WALK  
LEEDS  
LS11 9AR  
0113 391 6800 tel  
www.aecom.com

### ISSUE/REVISION

I/R	DATE	BY	DESCRIPTION
-	26/07/19	DC	FIRST ISSUE

### KEY PLAN

### SHEET TITLE

REFUSE\_VEHICLE\_TRACKING  
SITE\_10

### SHEET NUMBER

60593320-VT-LDP-010

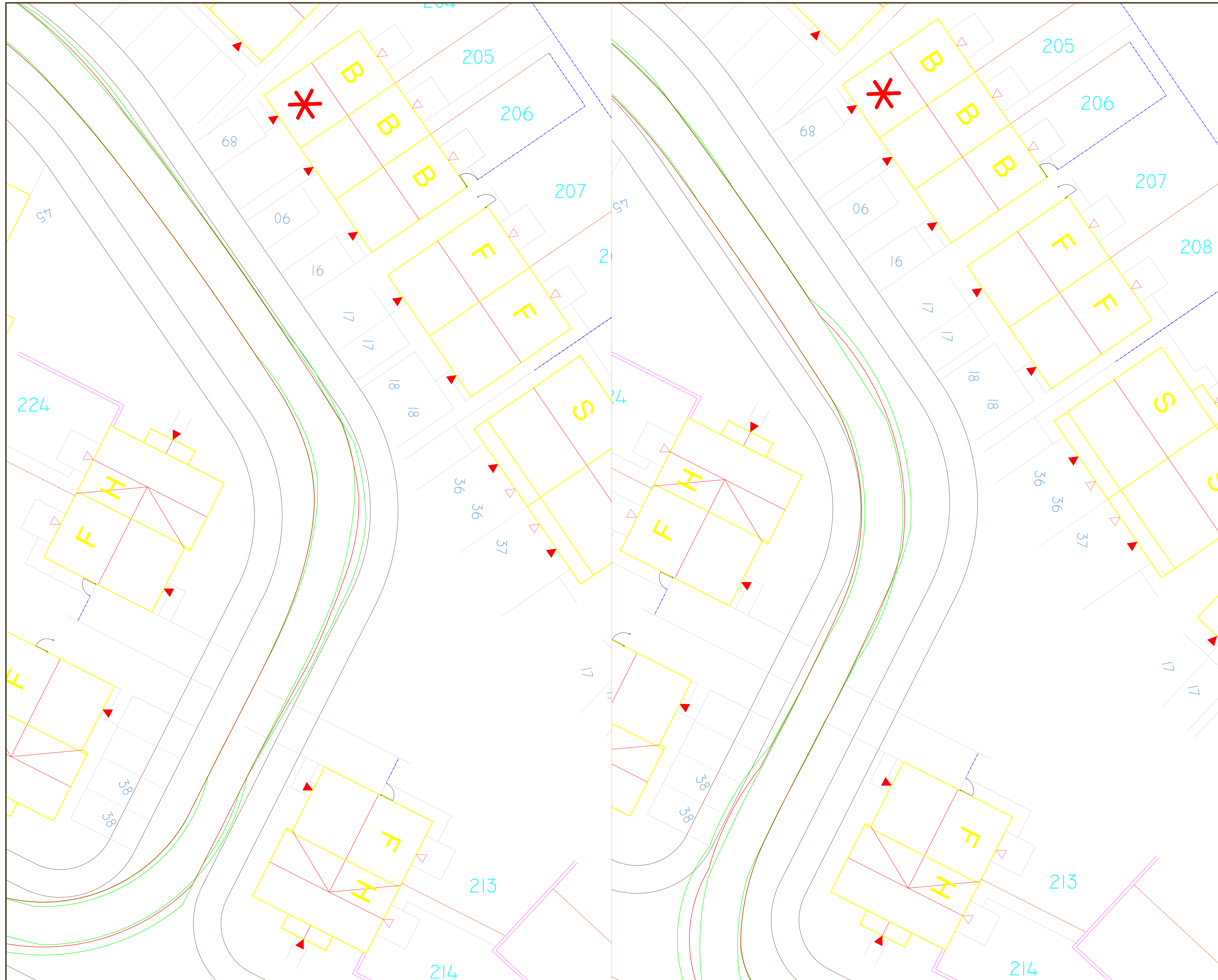

ISSUE/REVISION

I/R	DATE	BY	DESCRIPTION
-	26/07/19	DC	FIRST ISSUE

KEY PLAN

SHEET TITLE

REFUSE\_VEHICLE\_TRACKING  
SITE\_11

SHEET NUMBER

60593320-VT-LDP-011

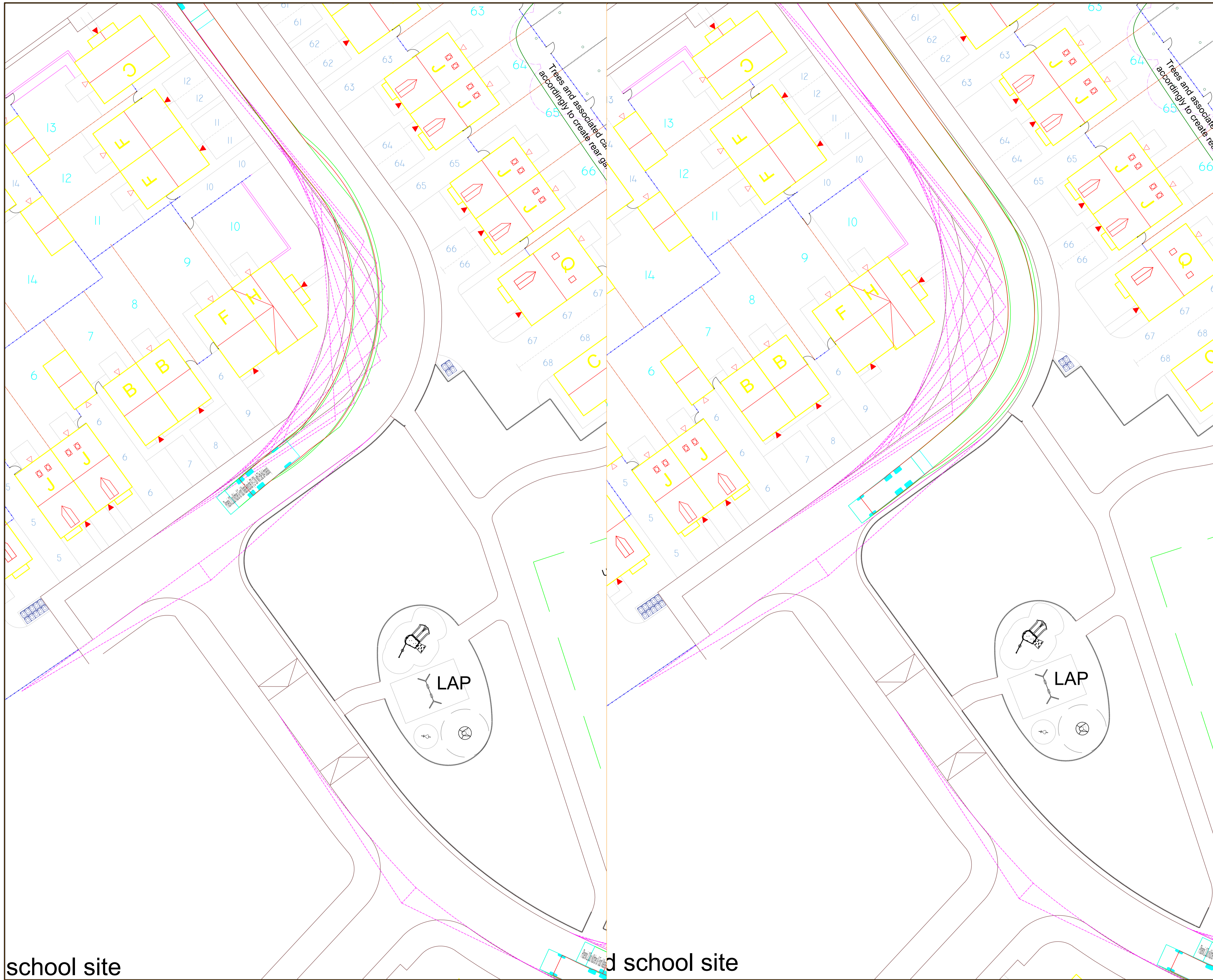

**ISSUE/REVISION**

I/R	DATE	BY	DESCRIPTION
A	31/07/2019	DC	SPA BASED ON AMENDMENTS FROM ARCHITECT
-	26/07/19	DC	FIRST ISSUE

**KEY PLAN**

school site

former school site

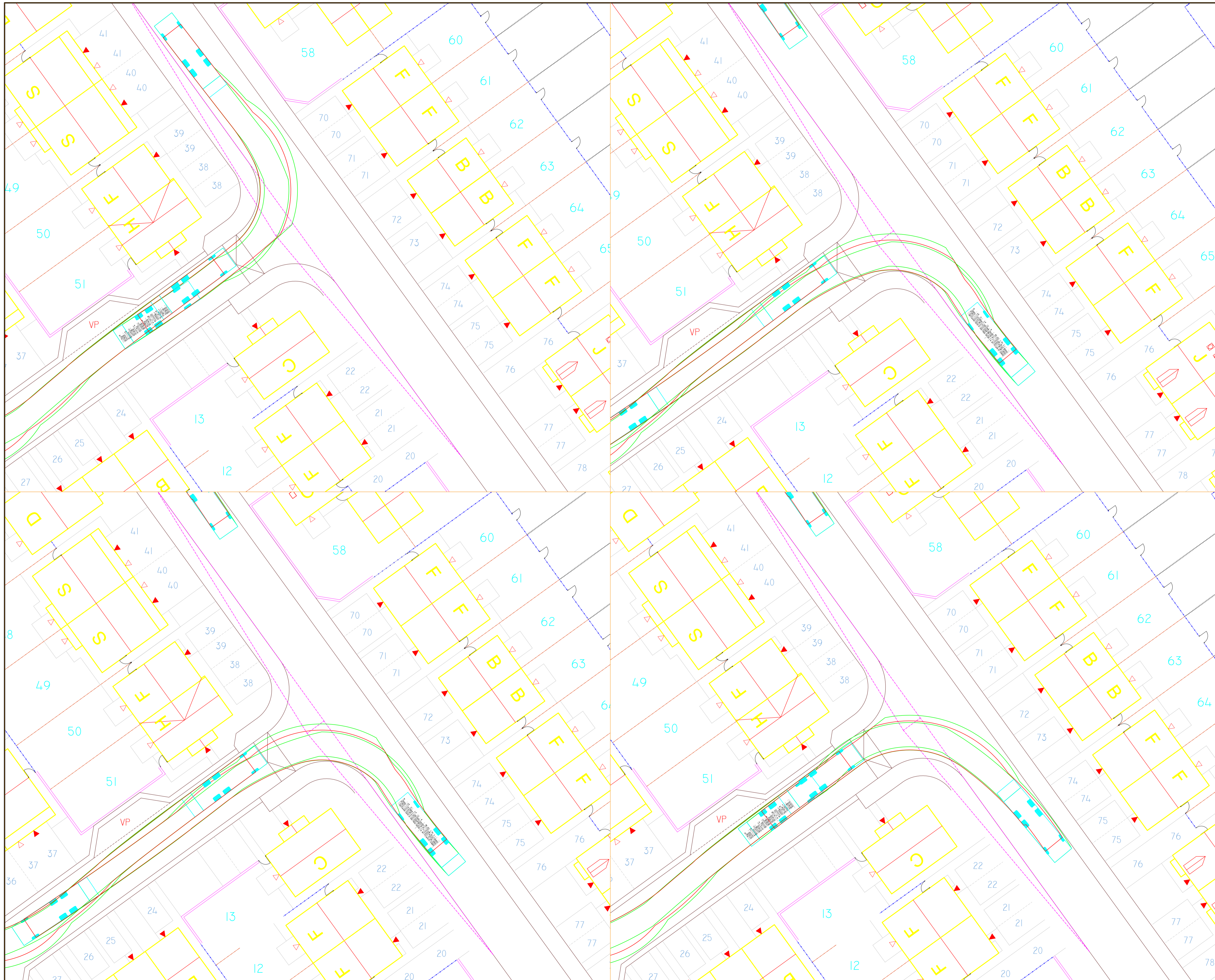

ISSUE/REVISION

I/R	DATE	BY	DESCRIPTION
-	26/07/19	DC	FIRST ISSUE

KEY PLAN

SHEET TITLE

REFUSE\_VEHICLE\_TRACKING  
SITE\_14

SHEET NUMBER

60593320-VT-LDP-013



ISSUE/REVISION

I/R	DATE	BY	DESCRIPTION
-	26/07/19	DC	FIRST ISSUE

KEY PLAN

SHEET TITLE

REFUSE\_VEHICLE\_TRACKING  
SITE\_15

SHEET NUMBER

60593320-VT-LDP-014

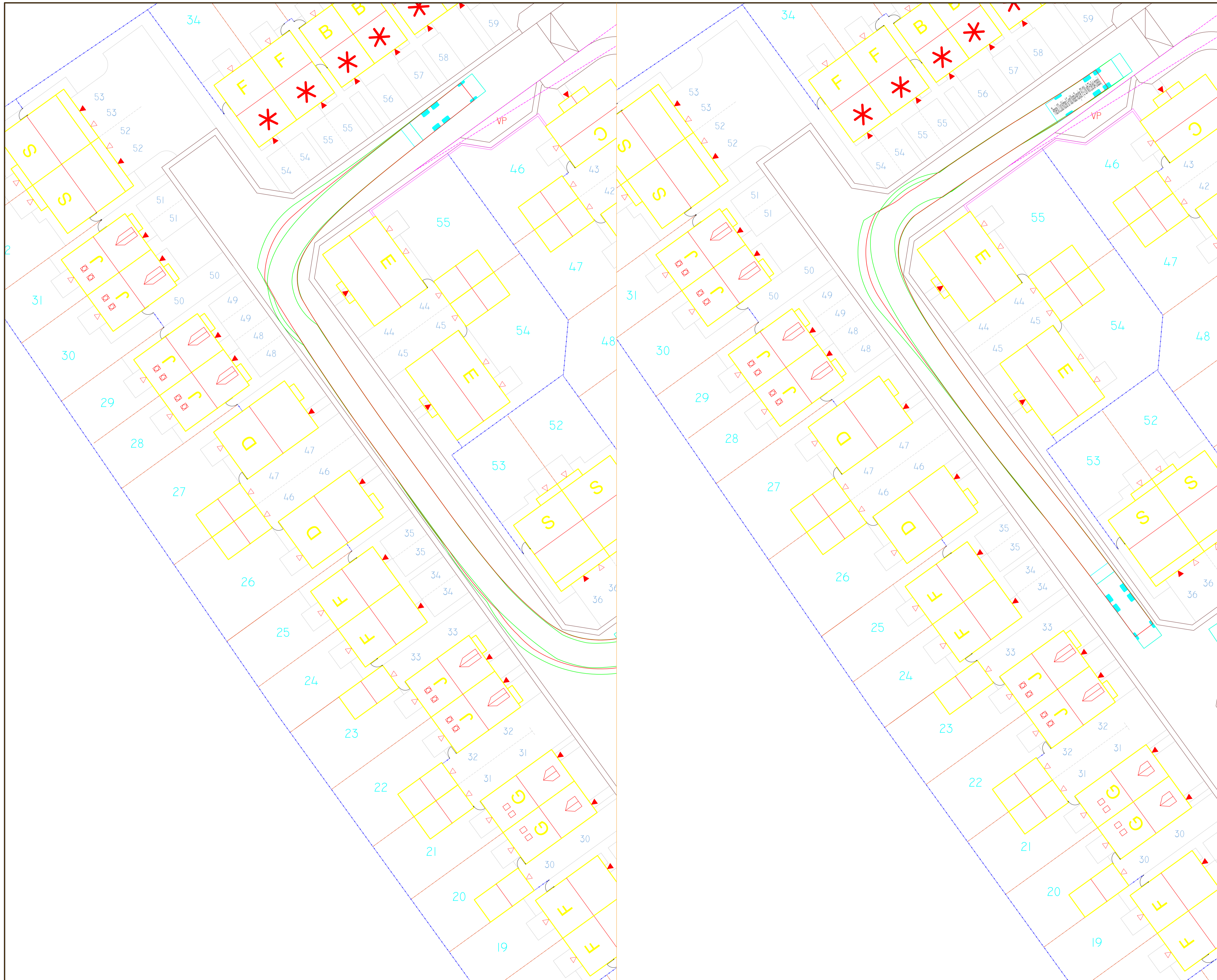

### ISSUE/REVISION

I/R	DATE	BY	DESCRIPTION
-	26/07/19	DC	FIRST ISSUE

### KEY PLAN

### SHEET TITLE

REFUSE\_VEHICLE\_TRACKING  
SITE\_16

### SHEET NUMBER

60593320-VT-LDP-015



ISSUE/REVISION

I/R	DATE	BY	DESCRIPTION
-	26/07/19	DC	FIRST ISSUE

KEY PLAN

SHEET TITLE

REFUSE\_VEHICLE\_TRACKING  
SITE\_17

SHEET NUMBER

60593320-VT-LDP-016

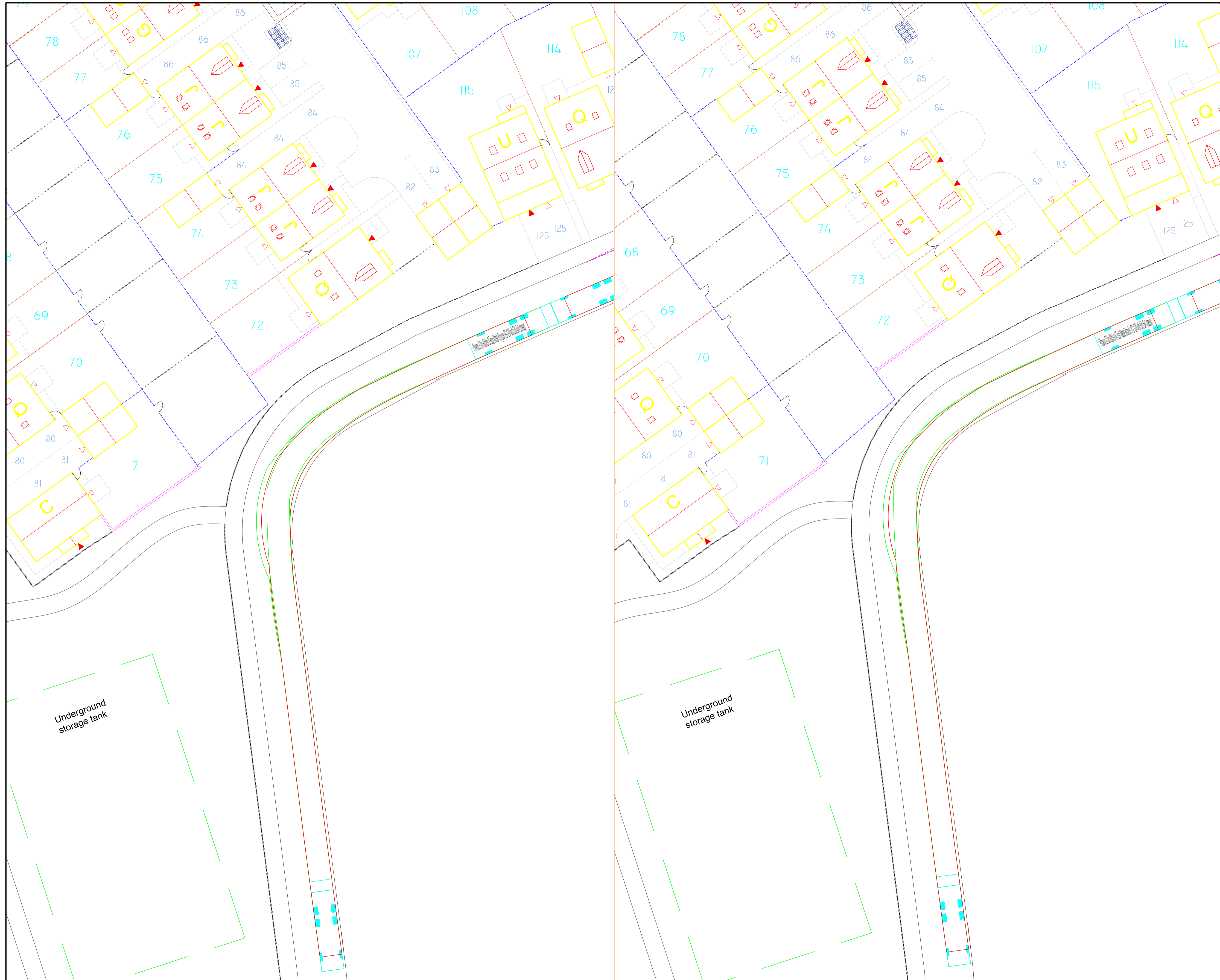

PROJECT

FORMER  
WOMBWELL  
SCHOOL

CLIENT

PREMIER  
CONSTRUCTION

CONSULTANT

AECOM LEEDS  
5th FLOOR  
2 CITY WALK  
LEEDS  
LS11 9AR  
0113 391 6800 tel  
www.aecom.com

ISSUE/REVISION

I/R	DATE	BY	DESCRIPTION
-	26/07/19	DC	FIRST ISSUE

KEY PLAN

SHEET TITLE

REFUSE\_VEHICLE\_TRACKING  
SITE\_18

SHEET NUMBER

60593320-VT-LDP-017

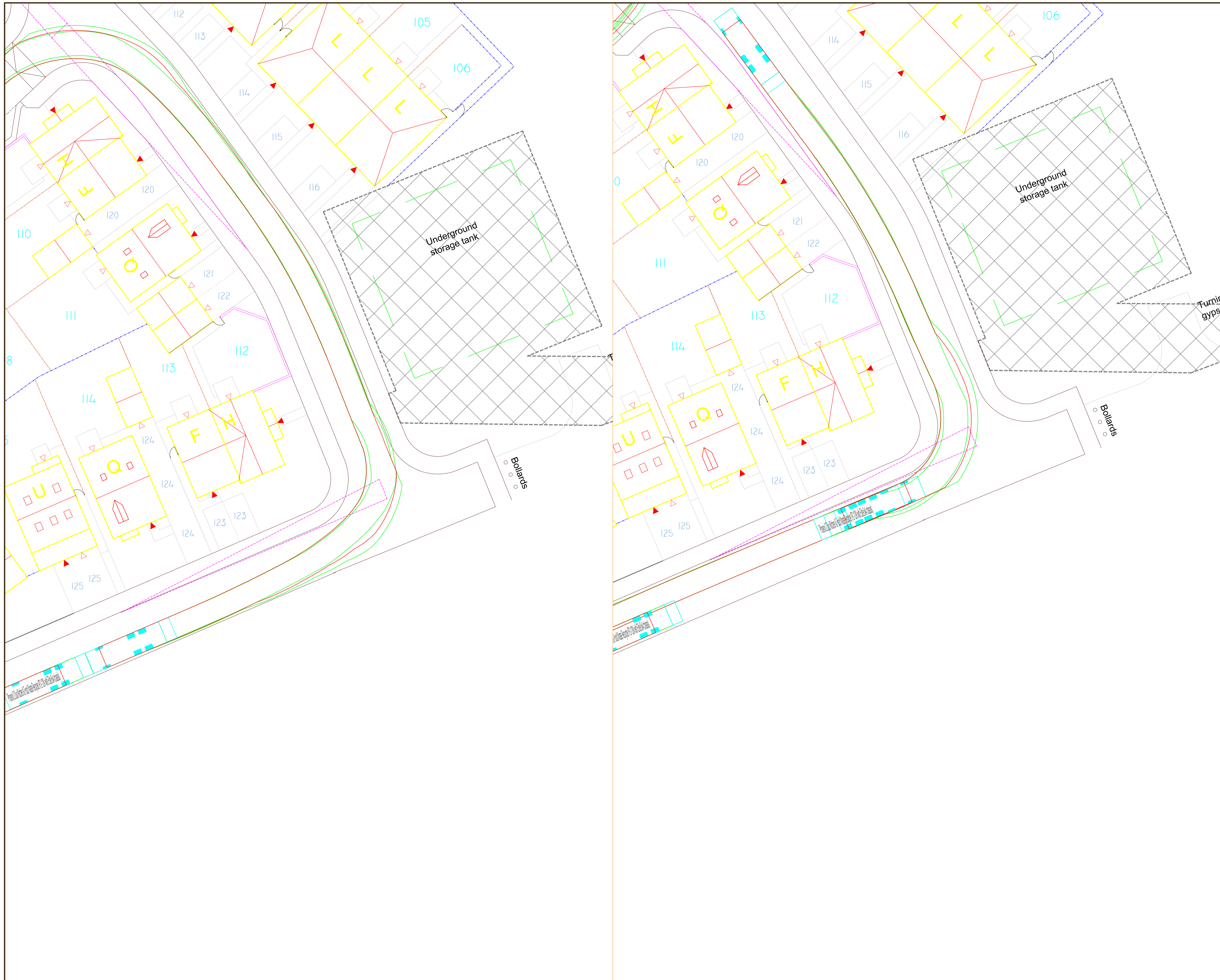

ISSUE/REVISION

I/R	DATE	BY	DESCRIPTION
-	26/07/19	DC	FIRST ISSUE

KEY PLAN

SHEET TITLE

REFUSE\_VEHICLE\_TRACKING  
 SITE\_19

SHEET NUMBER

60593320-VT-LDP-018



ISSUE/REVISION

I/R	DATE	BY	DESCRIPTION
-	26/07/19	DC	FIRST ISSUE

KEY PLAN

SHEET TITLE

REFUSE\_VEHICLE\_TRACKING  
SITE\_20

SHEET NUMBER

60593320-VT-LDP-019

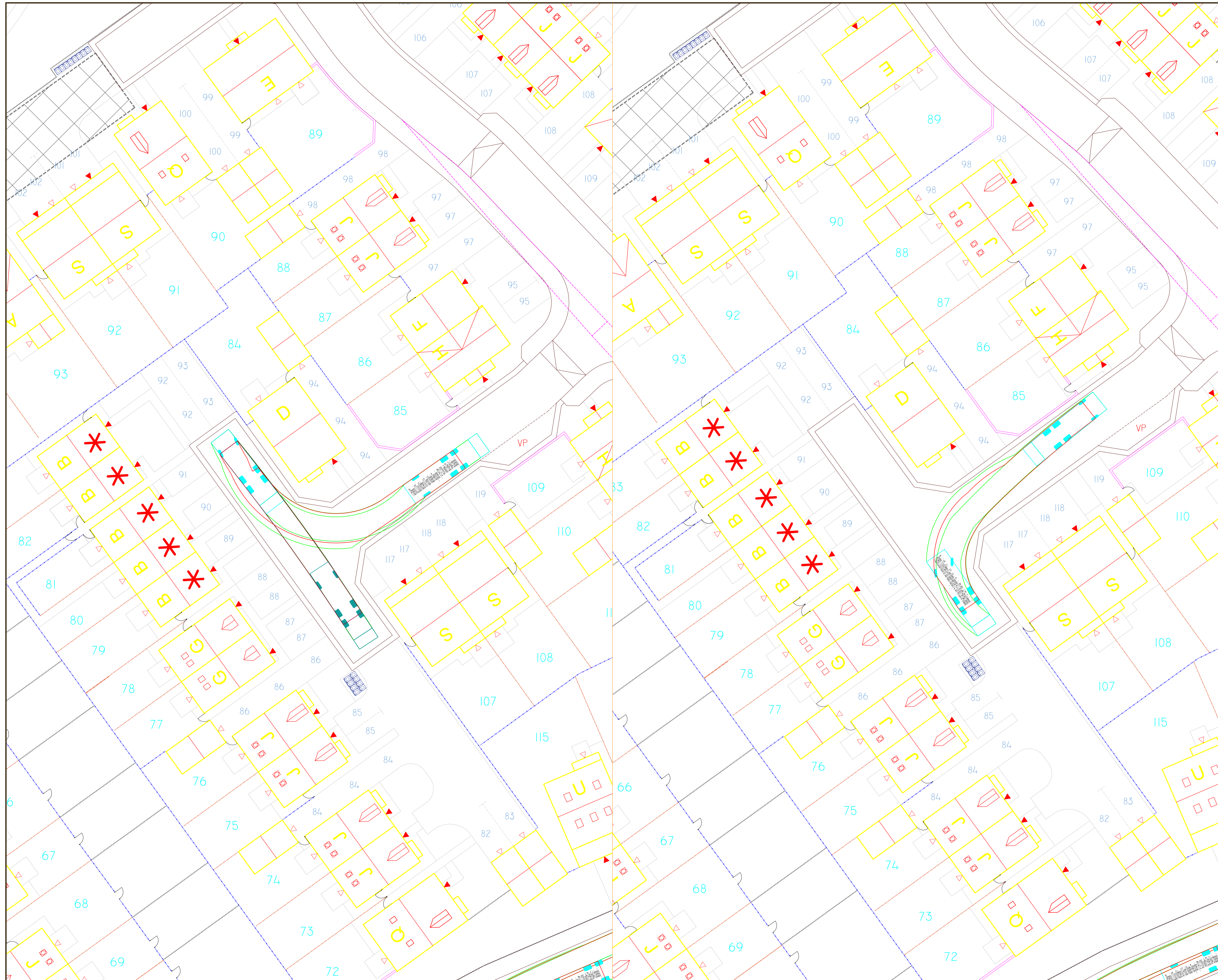

ISSUE/REVISION

I/R	DATE	BY	DESCRIPTION
-	26/07/19	DC	FIRST ISSUE

KEY PLAN

SHEET TITLE

REFUSE\_VEHICLE\_TRACKING  
SITE\_21

SHEET NUMBER

60593320-VT-LDP-020

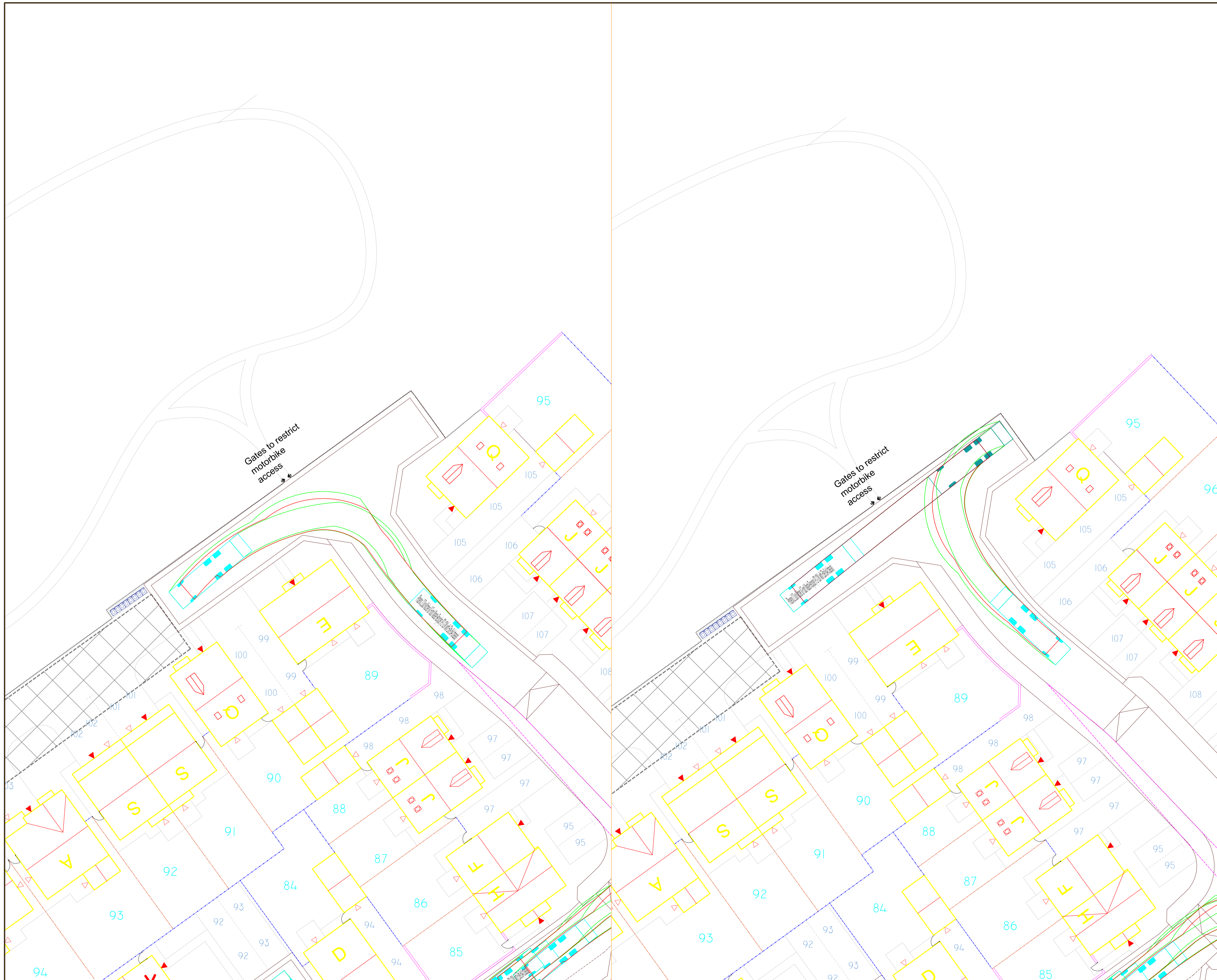

ISSUE/REVISION

I/R	DATE	BY	DESCRIPTION
-	26/07/19	DC	FIRST ISSUE

KEY PLAN

SHEET TITLE

REFUSE\_VEHICLE\_TRACKING  
SITE\_22

SHEET NUMBER

60593320-VT-LDP-021

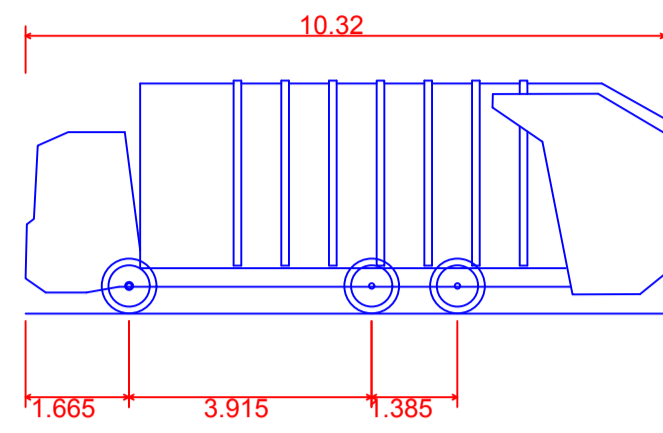

Phoenix 2 Duo Kitchen & Food Waste Recycler (P2-12W with Elite 6x4 chassis)  
 Overall Length 10.320m  
 Overall Width 2.530m  
 Overall Body Height 3.756m  
 Min Body Ground Clearance 0.309m  
 Track Width 2.530m  
 Lock to lock time 4.00s  
 Kerb to Kerb Turning Radius 9.450m

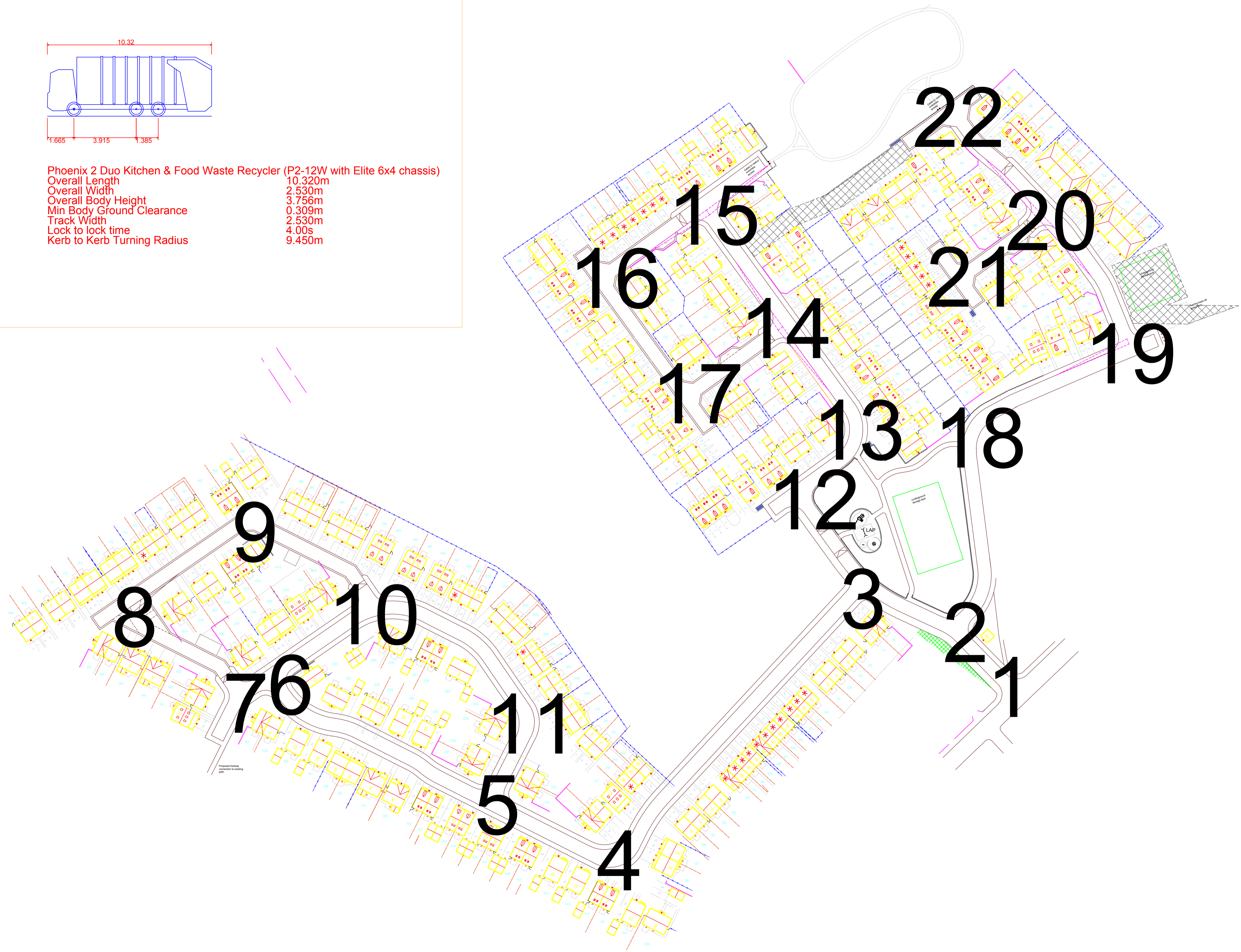

ISSUE/REVISION

I/R	DATE	BY	DESCRIPTION
-	26/07/19	DC	FIRST ISSUE

KEY PLAN

SHEET TITLE

REFUSE\_VEHICLE\_TRACKING  
 SITE\_OVERVIEW\_PLAN

SHEET NUMBER

60593320-VT-LDP-022