

"Z" flashing all around
except for opening

Double skin cladding 40mm

RSD 4.7 x 4mHt



Fire door

Thermo-roof

PVC valley gutter
+ 2 downpipes Ø125mm

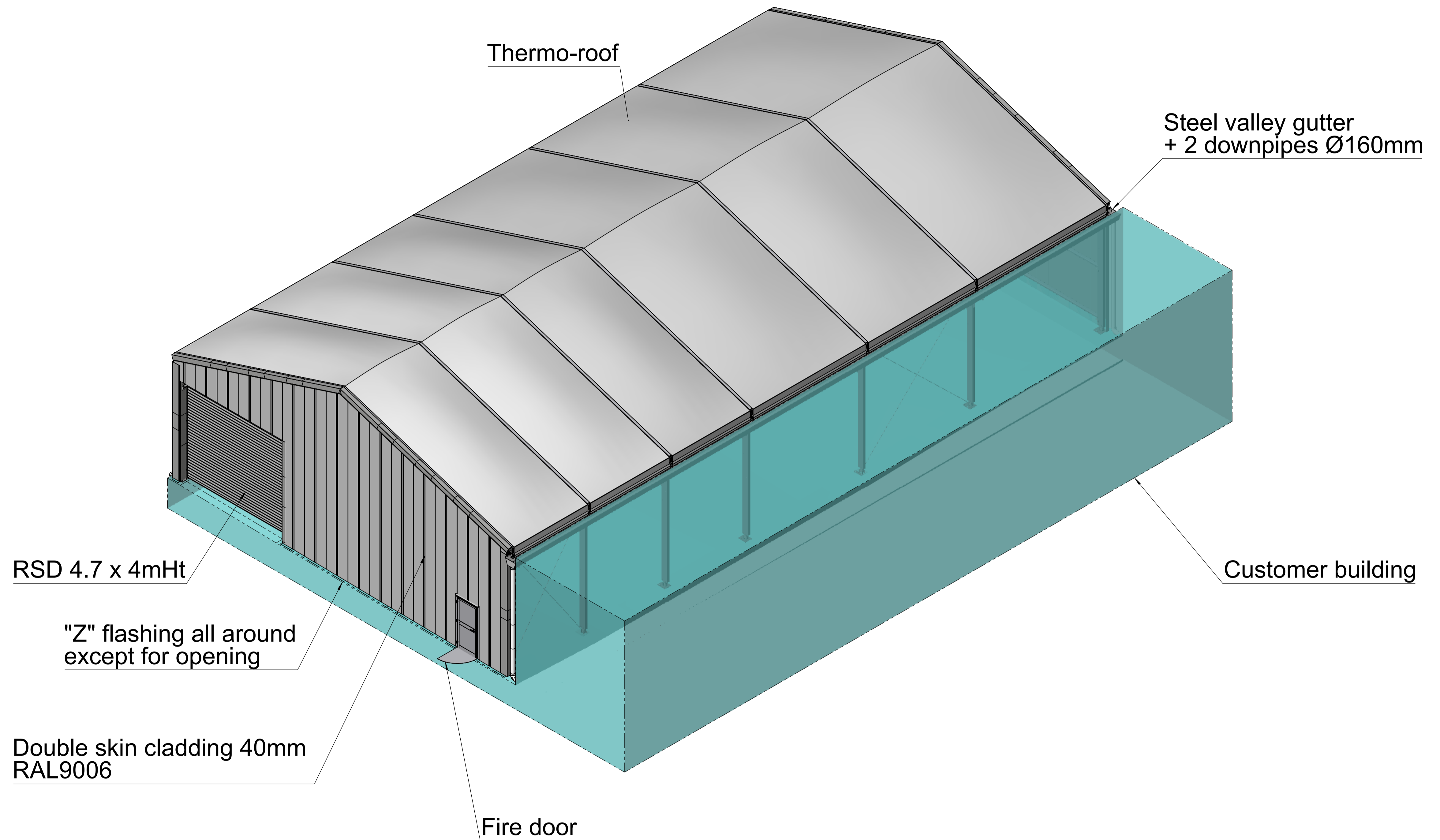
1	Creation	11/03/2021	NIPO
REV.	DESCRIPTION	DATE	NAME
Spécifications générales / General specifications ISO2768-mK √ Ra 3.2		DIMENSIONS EN MILLIMÈTRES - LA COTATION EST DÉFINIE APRÈS TRAITEMENT ARÊTES VIVES MACHÉES 0.2 A 45° - RAYONS D'OUTIL ADAMS 0.4 DIMENSIONS ARE IN MILLIMETERS - DIMENSIONS DEFINED AFTER TREATMENT SHARP EDGES CHAMFERED 0.2 x 45° - TOOL RADIUS 0.4 ADMITTED	
MATIERE / MATERIAL :		PROJET / PROJECT : Euroglaze	
TRAITEMENT / TREATMENT :	GAMME	APPLICATION	REF. A0005608
BATI-Stock 15x27.25m H5			
NOM / NAME : NIPO		DATE : 11/03/2021	ECH. / SCALE : 1:100
 23 rue de l'avenir 99700 SAVERDUN France Tel : +33 5 61 68 47 68		DRW-A0005608_1	FORMAT : A1 FOLIO : 1/9
<small>CE DOCUMENT EST LA PROPRIÉTÉ DE LAURALU - IL NE PEUT ÊTRE NI COMMUNIQUÉ À DES TIERS NI REPRODUIT SANS L'AUTORISATION PRÉALABLE ÉCRITE DE LAURALU THIS DOCUMENT IS THE EXCLUSIVE PROPERTY OF LAURALU - IT MUST NOT BE COMMUNICATED TO THIRD PARTIES OR REPRODUCED WITHOUT WRITTEN AUTHORIZATION FROM LAURALU</small>			



1	Creation	11/03/2021	NIPO
REV.	DESCRIPTION	DATE	NAME
Spécifications générales / General specifications		PROJET / PROJECT :	
ISO2768-mK √ Ra 3.2		Euroglaze	
Matière / Material :			
TRAITEMENT / TREATMENT :		GAMME	APPLICATION
		REF: A0005608	
BATI-Stock 15x27.25m H5			
NOM / NAME : NIPO		DATE : 11/03/2021	ECH. / SCALE : 1:100
 <small>23 rue de l'avenir 92700 SAVERDUN France Tel: +33 5 61 68 47 68</small>		DRW-A0005608_1	
<small>CE DOCUMENT EST LA PROPRIÉTÉ DE LAURALU. IL NE PEUT ÊTRE NI COMMUNIQUÉ À DES TIERS NI REPRODUIT SANS L'AUTORISATION PRÉALABLE ÉCRITE DE LAURALU. THIS DOCUMENT IS THE EXCLUSIVE PROPERTY OF LAURALU. IT MUST NOT BE COMMUNICATED TO THIRD PARTIES OR REPRODUCED WITHOUT WRITTEN AUTHORIZATION FROM LAURALU.</small>			

LED Lighting

Bottom roof wire
L6050mm



Top roof wire
L4215mm

Top roof wire
L4215mm

Bottom roof wire
L6050mm

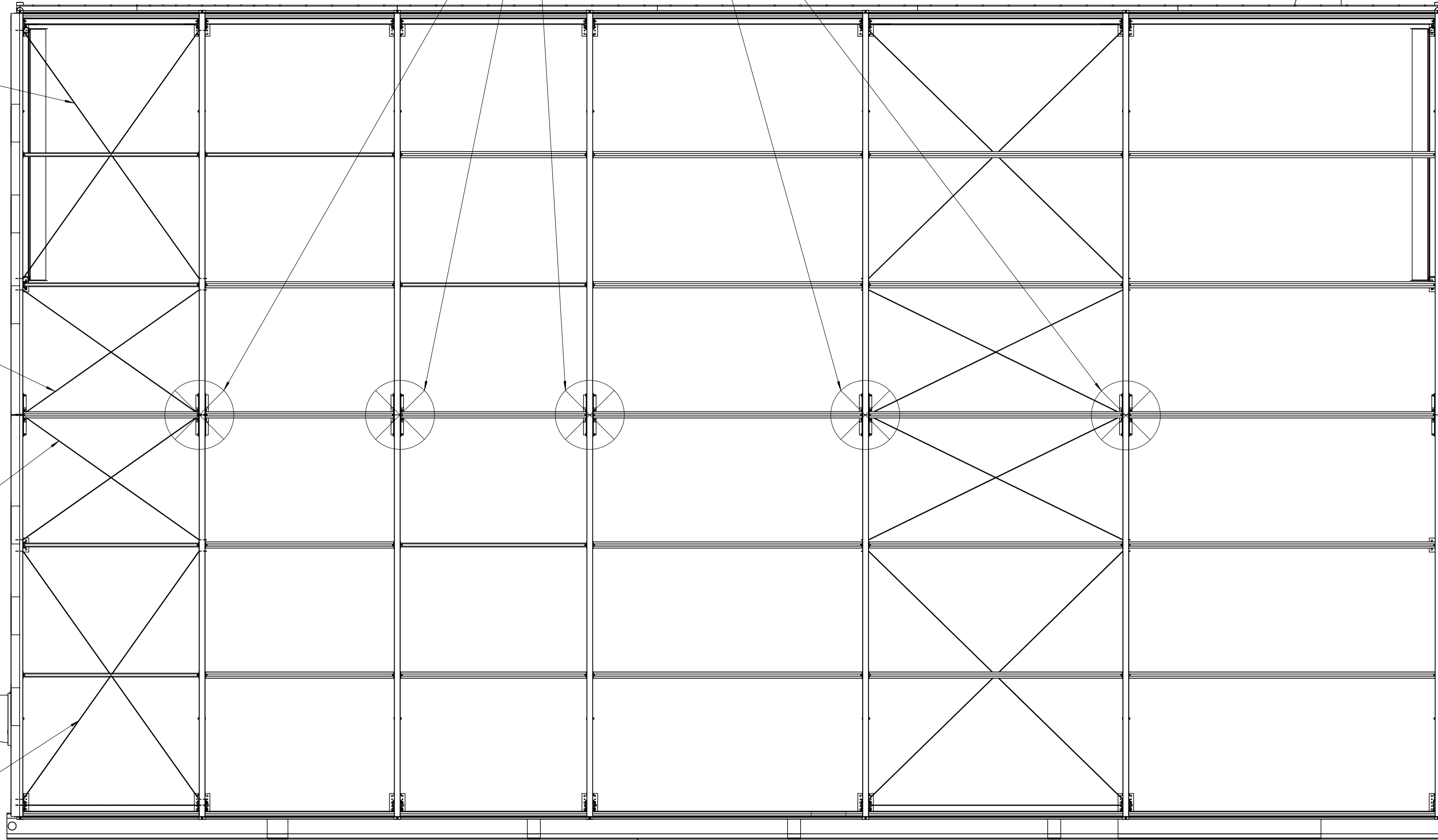
Steel valley gutter



1	Creation	11/03/2021	NIPO
REV.	DESCRIPTION	DATE	NAME
Spécifications générales / General specifications ISO2768-mK √ Ra 3.2		DIMENSIONS EN MILLIMÈTRES - LA COTATION EST DÉFINIE APRÈS TRAITEMENT ARÊTES VIVES MÔUCHÉES 0.2 A 45° - RAYONS D'OUTIL ADAMS 0.4 DIMENSIONS ARE IN MILLIMETERS - DIMENSIONS DEFINED AFTER TREATMENT SHARP EDGES CHAMFERED 0.2 x 45° - TOOL RADIUS 0.4 ADMITTED	
Matière / Material :		PROJET / PROJECT : Euroglaze	
TRAITEMENT / TREATMENT :		GAMME	APPLICATION
		REF: A0005608	
		BATI-Stock 15x27.25m H5	
NOM / NAME : NIPO		DATE : 11/03/2021	ECH. / SCALE : 1:100
 23 rue de l'Éclair 59700 SAVERDUN France Tel : +33 5 61 68 47 68		DRW-A0005608_1 	
<small>CE DOCUMENT EST LA PROPRIÉTÉ DE LAURALU - IL NE PEUT ÊTRE NI COMMUNIQUÉ À DES TIERS NI REPRODUIT SANS L'AUTORISATION PRÉALABLE ÉCRITE DE LAURALU THIS DOCUMENT IS THE EXCLUSIVE PROPERTY OF LAURALU - IT MUST NOT BE COMMUNICATED TO THIRD PARTIES OR REPRODUCED WITHOUT WRITTEN AUTHORIZATION FROM LAURALU</small>			

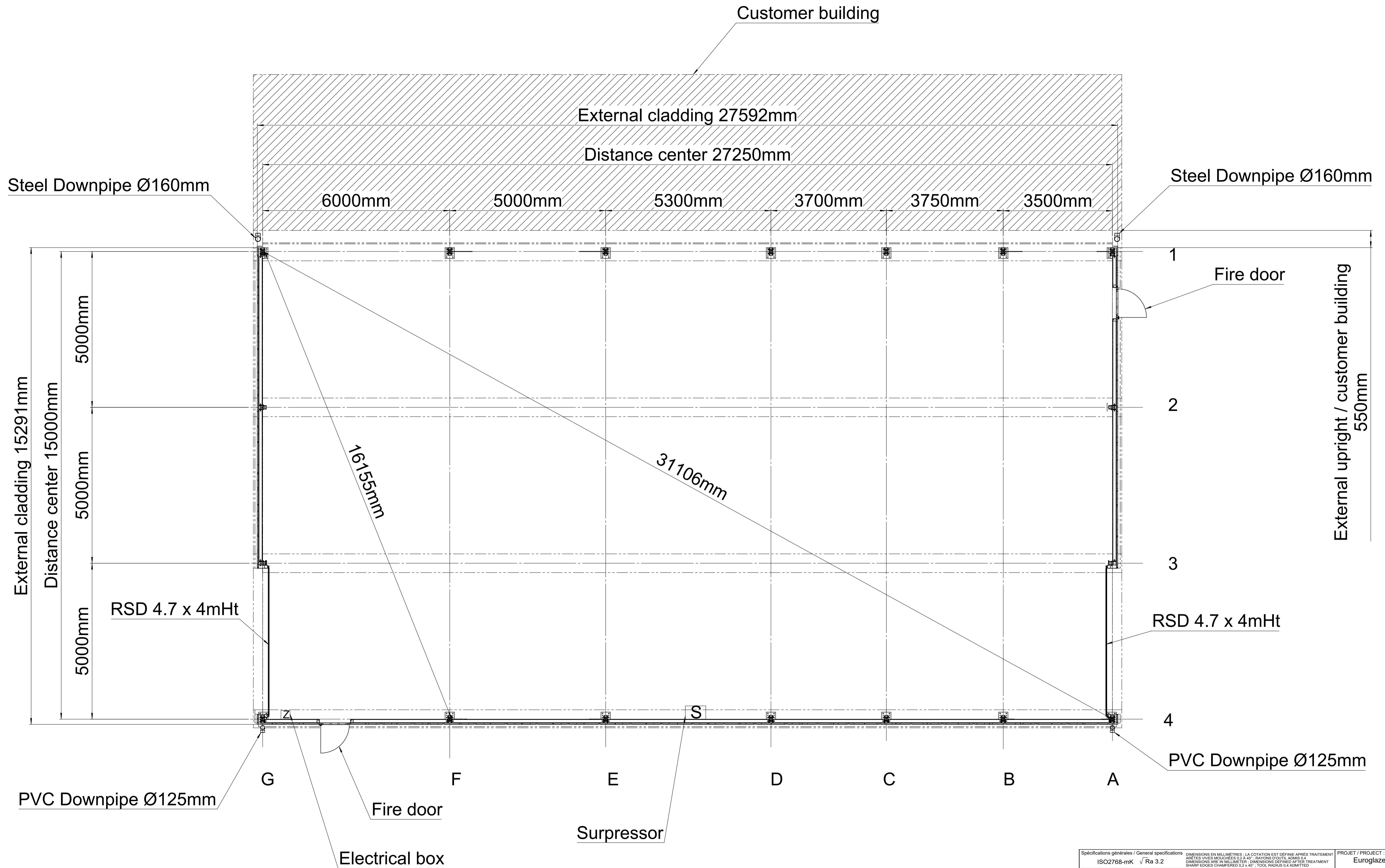

Spécifications générales / General specifications ISO2768-mK √ Ra 3.2		DIMENSIONS EN MILLIMÈTRES - LA COTATION EST DÉFINIE APRÈS TRAITEMENT ARÊTES VIVES MÔUCHÊTES 0.2 A 45° - RAYONS D'OUTIL ADAMS 0.4 DIMENSIONS ARE IN MILLIMETERS - DIMENSIONS DEFINED AFTER TREATMENT SHARP EDGES CHAMFERED 0.2 x 45° - TOOL RADIUS 0.4 ADMITTED		PROJET / PROJECT : Euroglaze
MATIERE / MATERIAL :		REF: A0005608		
TRAITEMENT / TREATMENT :		GAMME APPLICATION BATI-Stock 15x27.25m H5		
NOM / NAME : NIPO		DATE : 11/03/2021	ECH. / SCALE : 1:150	
23 rue de l'avenir 59700 SAVERDUN France Tel: +33 5 61 68 47 68		DRW-A0005608_1		
CE DOCUMENT EST LA PROPRIÉTÉ DE LAURALU - IL NE PEUT ÊTRE NI COMMUNIQUÉ À DES TIERS NI REPRODUIT SANS L'AUTORISATION PRÉALABLE ÉCRITE DE LAURALU THIS DOCUMENT IS THE EXCLUSIVE PROPERTY OF LAURALU - IT MUST NOT BE COMMUNICATED TO THIRD PARTIES OR REPRODUCED WITHOUT WRITTEN AUTHORIZATION FROM LAURALU		LAURALU FORMAT: A1 FOLIO: 4/9		

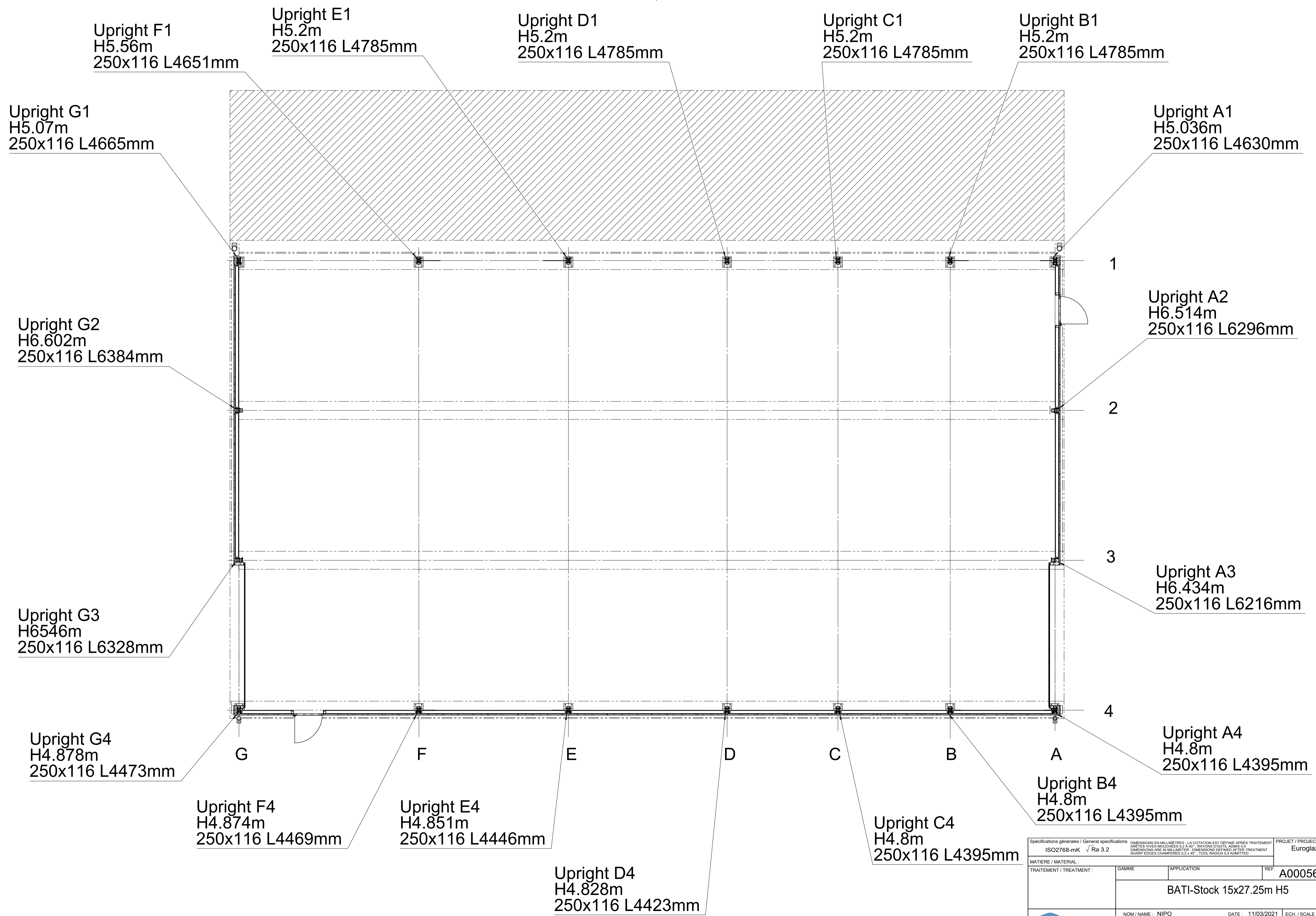

Spécifications générales / General specifications ISO2768-mK √ Ra 3.2		DIMENSIONS EN MILLIMÈTRES - LA COTATION EST DÉFINIE APRÈS TRAITEMENT ARÊTES VIVES MOUTCHÉES 0.2 A 45° - RAYONS D'OUTIL ADAMS 0.4 DIMENSIONS ARE IN MILLIMETERS - DIMENSIONS DEFINED AFTER TREATMENT SHARP EDGES CHAMFERED 0.2 x 45° - TOOL RADIUS 0.4 ADMITTED		PROJET / PROJECT : Euroglaze
MATIERE / MATERIAL :		REF: A0005608		
TRAITEMENT / TREATMENT :		GAMME APPLICATION BATI-Stock 15x27.25m H5		
NOM / NAME : NIPO		DATE : 11/03/2021	ECH. / SCALE : 1:150	
LAURALU 23 rue de l'avenir 92700 SAVERDUN France Tel: +33 5 61 68 47 68		FORMAT FOLIO A1 5/9		
DRW-A0005608_1				
<small>CE DOCUMENT EST LA PROPRIÉTÉ DE LAURALU. IL NE PEUT ÊTRE NI COMMUNIQUÉ À DES TIERS NI REPRODUIT SANS L'AUTORISATION PRÉALABLE ÉCRITE DE LAURALU. THIS DOCUMENT IS THE EXCLUSIVE PROPERTY OF LAURALU. IT MUST NOT BE COMMUNICATED TO THIRD PARTIES OR REPRODUCED WITHOUT WRITTEN AUTHORIZATION FROM LAURALU.</small>				

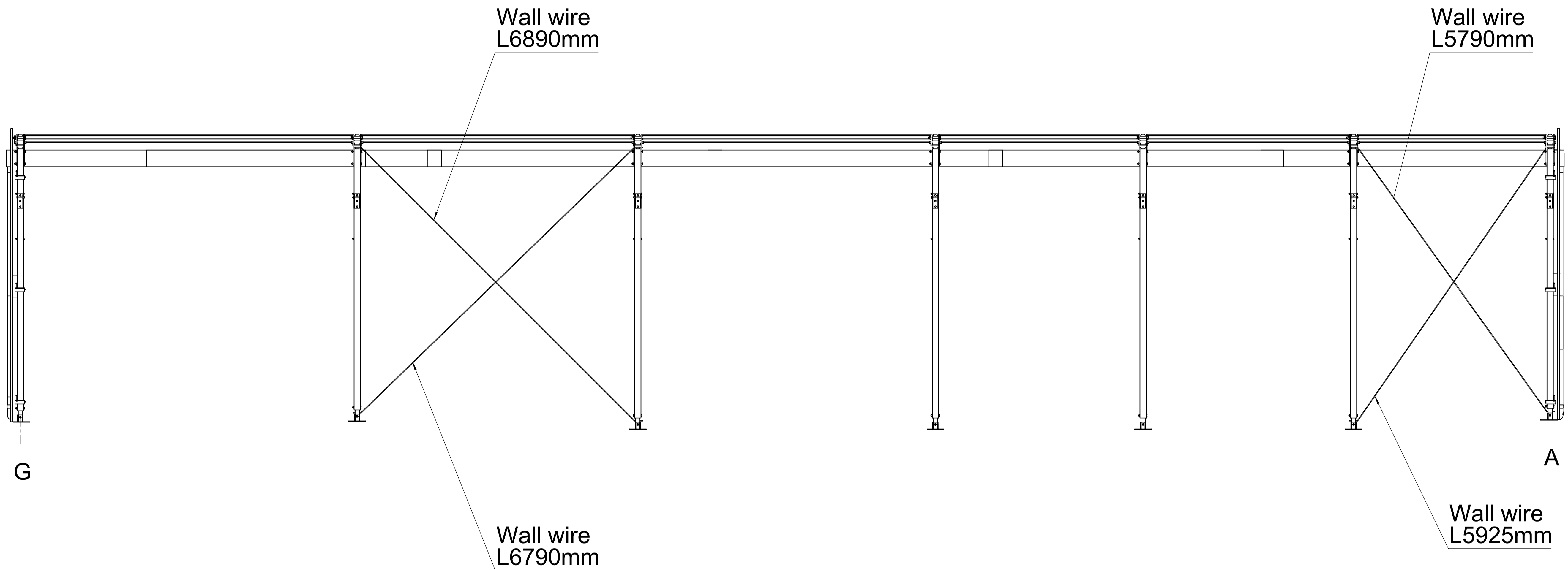

File 1

Spécifications générales / General specifications ISO2768-mK √ Ra 3.2		DIMENSIONS EN MILLIMÈTRES : LA COTATION EST DÉFINIE APRÈS TRAITEMENT ARÊTES VIVES MOUTCHÉES 0.2 A 45° - RAYONS D'OUTIL ADAMS 0.4 DIMENSIONS ARE IN MILLIMETERS : DIMENSIONS DEFINED AFTER TREATMENT SHARP EDGES CHAMFERED 0.2 x 45° - TOOL RADIUS 0.4 ADMITTED		PROJET / PROJECT : Euroglaze	
MATIERE / MATERIAL :		GAMME / APPLICATION :		REF. : A0005608	
TRAITEMENT / TREATMENT :		BATI-Stock 15x27.25m H5			
NOM / NAME : NIPO		DATE : 11/03/2021		ECH. / SCALE : 1:200	
23 rue de l'avenir 97700 SAVERDUN France Tel : +33 5 61 68 47 68		DRW-A0005608_1		FORMAT : A1 FOLIO : 6/9	
<small>CE DOCUMENT EST LA PROPRIÉTÉ DE LAURALU. IL NE PEUT ÊTRE NI COMMUNIQUÉ À DES TIERS NI REPRODUIT SANS L'AUTORISATION PRÉALABLE ÉCRITE DE LAURALU. THIS DOCUMENT IS THE EXCLUSIVE PROPERTY OF LAURALU. IT MUST NOT BE COMMUNICATED TO THIRD PARTIES OR REPRODUCED WITHOUT WRITTEN AUTHORIZATION FROM LAURALU.</small>					

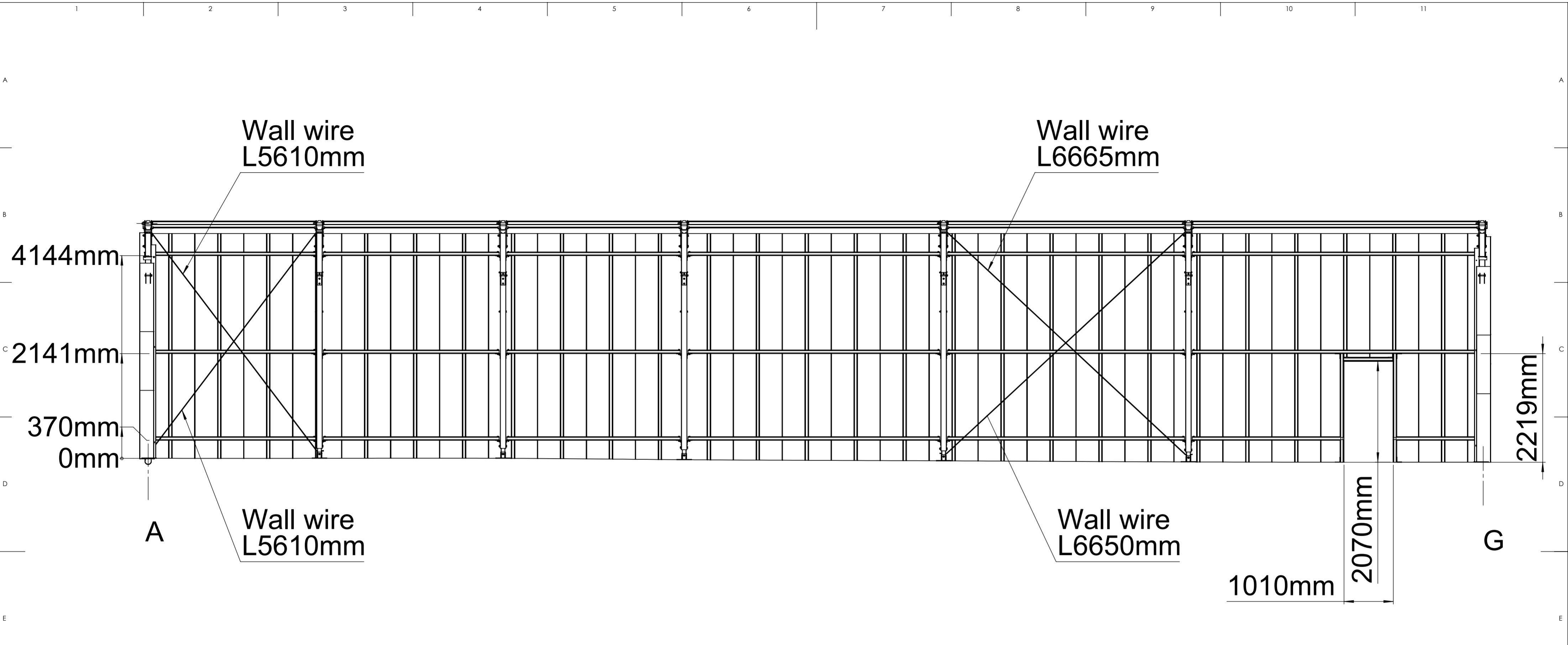

File 4

Spécifications générales / General specifications		DIMENSIONS EN MILLIMÈTRES : LA COTATION EST DÉFINIE APRÈS TRAITEMENT ARÊTES VIVES MOUCHÉES 0.2 À 45° ; RAYONS D'OUTIL ADMIS 0.4 DIMENSIONS ARE IN MILLIMETER : DIMENSIONS DEFINED AFTER TREATMENT SHARP EDGES CHAMFERED 0.2 x 45° ; TOOL RADIUS 0.4 ADMITTED		PROJET / PROJECT :
ISO2768-mK \sqrt{Ra} 3.2				Euroglaze
MATIERE / MATERIAL :				
TRAITEMENT / TREATMENT :	GAMME	APPLICATION	REF.	A0005608
		BATI-Stock 15x27.25m H5		
NOM / NAME : NIPO		DATE : 11/03/2021	ECH. / SCALE : 1:200	
 23 rue de l'Avenir 09700 SAVERDUN France Tel: +33 5 61 68 47 68		DRW - A 0 0 0 5 6 0 8 , 1		FORMAT : A2 FOLIO : 7/9
<small>CE DOCUMENT EST LA PROPRIÉTÉ DE LAURALU ; IL NE PEUT ÊTRE NI COMMUNIQUÉ À DES TIERS, NI REPRODUIT SANS L'AUTORISATION PRÉALABLE ÉCRITE DE LAURALU THIS DOCUMENT IS THE EXCLUSIVE PROPERTY OF LAURALU ; IT MUST NOT BE COMMUNICATED TO THIRD PARTIES OR REPRODUCED WITHOUT WRITTEN AUTHORIZATION FROM LAURALU</small>				

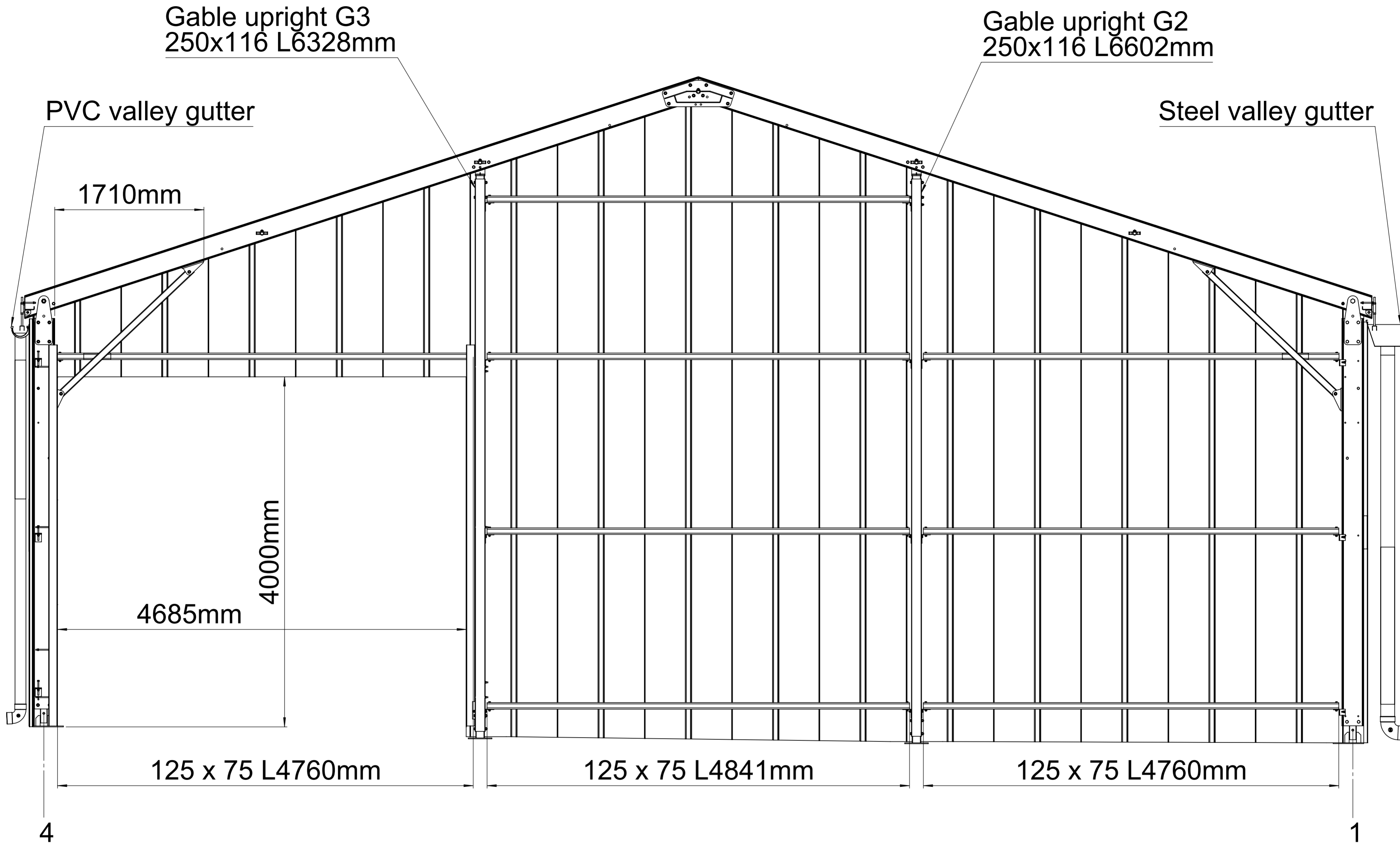

File G

Spécifications générales / General specifications		DIMENSIONS EN MILLIMÈTRES : LA COTATION EST DÉFINIE APRÈS TRAITEMENT		PROJET / PROJECT :	
ISO2768-mK \sqrt{Ra} 3.2		ARÊTES VIVES MOUCHÉES 0.2 À 45° ; RAYONS D'OUTIL ADMIS 0.4		Euroglaze	
MATERIE / MATERIAL :		TRAITEMENT / TREATMENT :		REF. A0005608	
		GAMME		APPLICATION	
		BATI-Stock 15x27.25m H5			
NOM / NAME : NIPO		DATE : 11/03/2021		ECH. / SCALE : 1:200	
 23 rue de l'Avenir 09700 SAVERDUN France Tel: +33 5 61 68 47 68		DRW - A 0 0 0 5 6 0 8 1		FORMAT : A2 FOLIO : 9/9	
<small>CE DOCUMENT EST LA PROPRIÉTÉ DE LAURALU - IL NE PEUT ÊTRE NI COMMUNIQUÉ À DES TIERS, NI REPRODUIT SANS L'AUTORISATION PRÉALABLE ÉCRITE DE LAURALU THIS DOCUMENT IS THE EXCLUSIVE PROPERTY OF LAURALU - IT MUST NOT BE COMMUNICATED TO THIRD PARTIES OR REPRODUCED WITHOUT WRITTEN AUTHORIZATION FROM LAURALU</small>					